

# PLANTA CAPEAMENTO ASFÁLTICO

ESCALA 1: 800

## CORTE A-A'

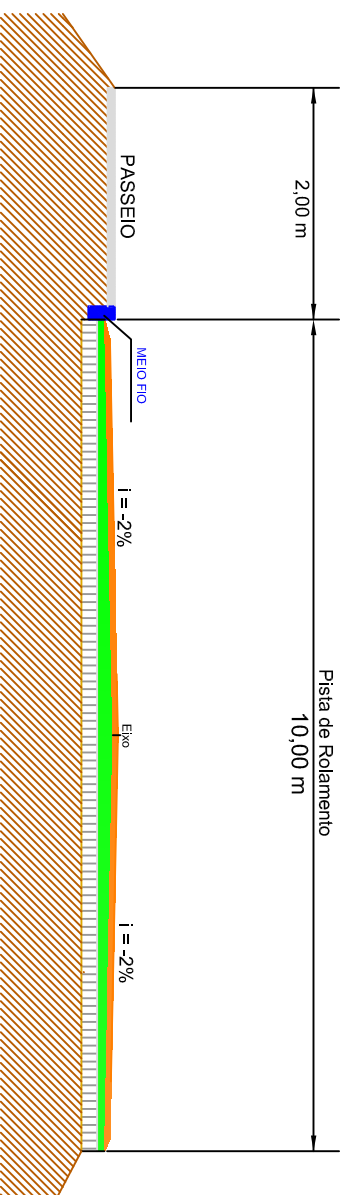

### DETALHE DA IMPLANTAÇÃO REVESTIMENTO ASFÁLTICO

	CBUQ	(e = 0,05 m)
	BGS	(e = 0,15 m)
	Macadame Seco	(e = 0,20 m)

Av. Borges de Medeiros, 615 - Sala 104 Getúlio Vargas - RS - CEP 99900-000 Fone: 54-3341 3753 / 54-99950 5335		Resp. Técnico: .....	Cliente: .....
Projeto : Lauson Serafini	Data : Novembro/2018	Resp. Técnico : Eng. Civil Lauson Serafini      CREA/RS 123168-D	
Desenho: Diego Kichel	Escala : Indicada	Cliente: Pref. Municipal de Tupanci do Sul      CNPJ: 90.484.320/0001-57	Local : Rua Antônio Zotti
Aprovação: -	Revisão : 00	Local : Rua Antônio Zotti	Conteúdo: Planta de Capejamento Asfáltico
Prancha : 22	Aproveitamento: -	Conteúdo: Planta de Capejamento Asfáltico	

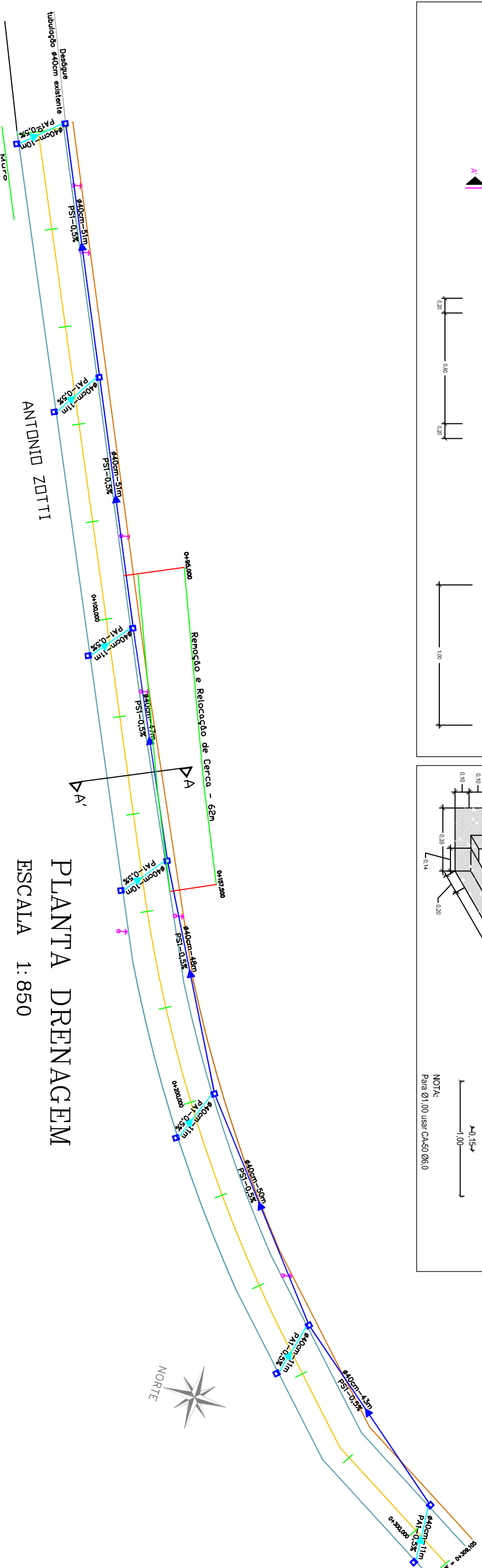
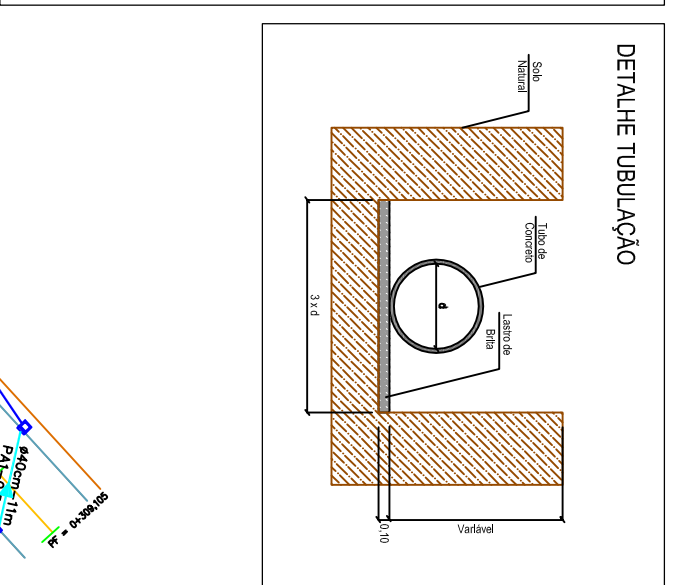
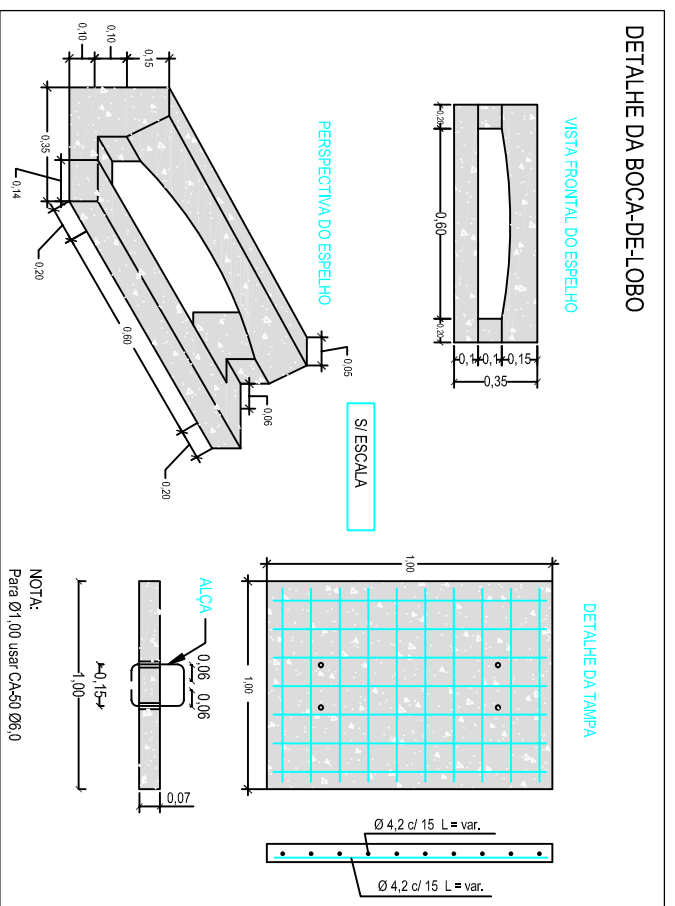
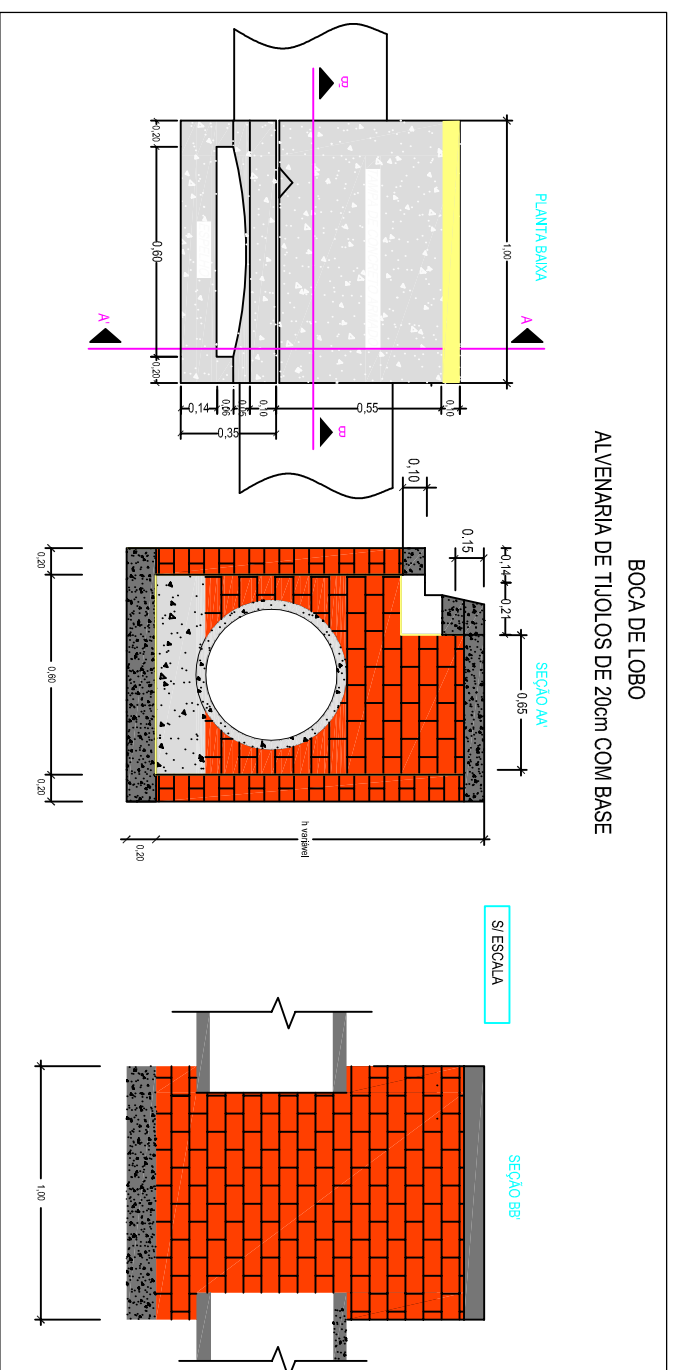

### LEGENDA:

	Caixa de Inspeção - Existente
	Boca de Lobo - Existente
	Boca de Lobo - Projetada
	Caixa de Inspeção - Projetada
	Tubo de Concreto Simples - PSI
	Tubo de Concreto Armado - PA1
	Meio Fio de Concreto
	Ald

Av. Borges de Medeiros, 615 - Sala 104 Getúlio Vargas - RS - CEP 99900-000 Fone: 54-3341 3753 / 54-99950 5335		Resp. Técnico: .....	Cliente: .....
Projeto : Lauson Serafini	Data : Novembro/2018	Resp. Técnico : Eng. Civil Lauson Serafini CREA/RS 123168-D	
Desenho: Diego Kichel	Escala : Indicada	Cliente: Pref. Municipal de Tupanci do Sul CNPJ: 90.484.320/0001-57	Local : Rua Antônio Zotti
Aprovação: -	Revisão : 00	Prancha : 24	Conteúdo: Planta de Drenagem Pluvial

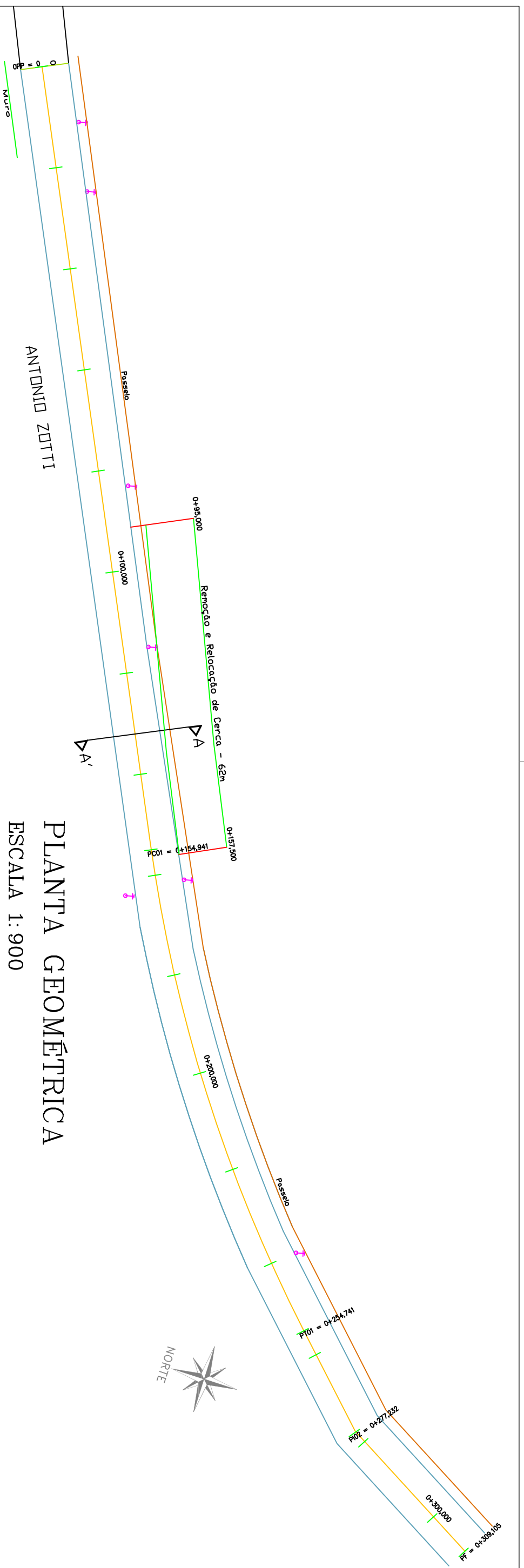

# PLANTA GEOMÉTRICA

## ESCALA 1: 900

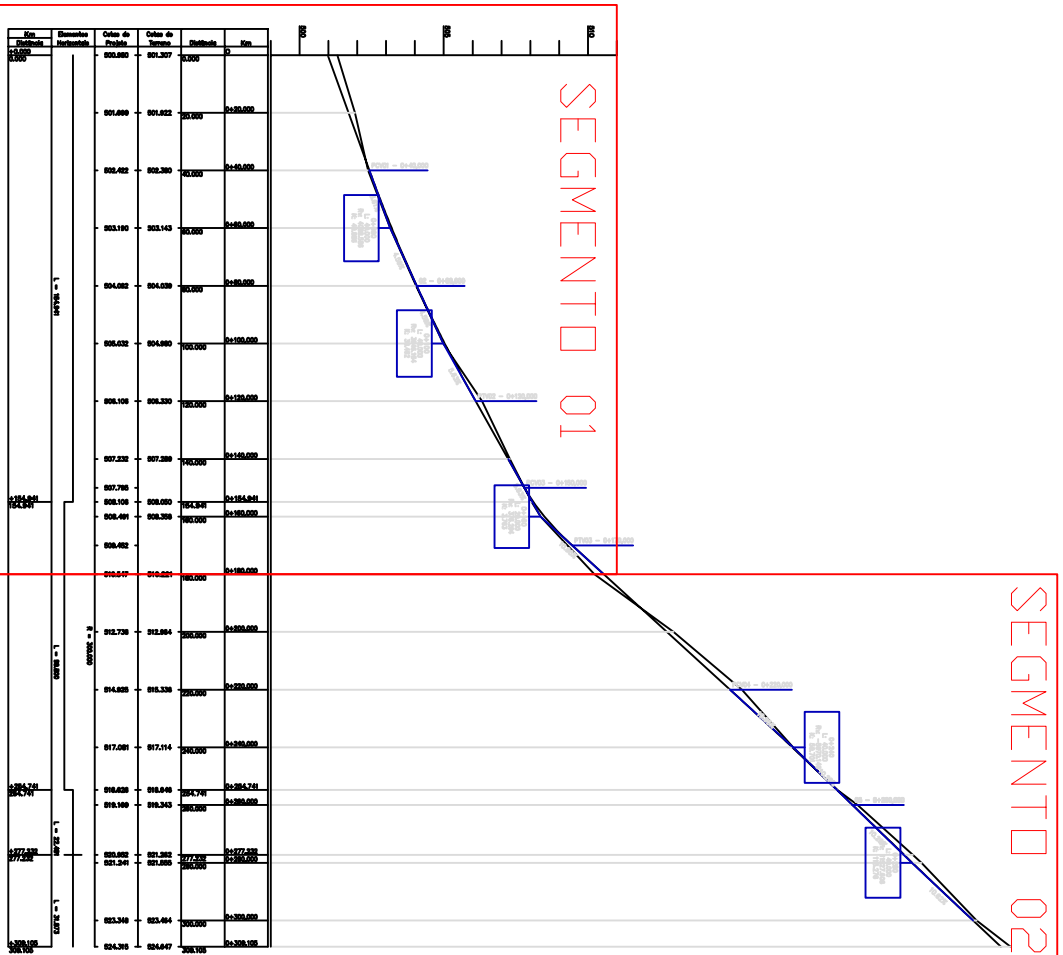

Av. Borges de Medeiros, 615 - Sala 104 Getúlio Vargas - RS - CEP 99900-000 Fone: 54-3341 3753 / 54-99950 5335		Resp. Técnico: .....	Cliente: .....
Projeto : Lauson Serafini	Data : Novembro/2018	Resp. Técnico : Eng. Civil Lauson Serafini      CREA/RS 123168-D	
Desenho: Diego Kichel	Escala : Indicada	Cliente: Pref. Municipal de Tupanci do Sul      CNPJ: 90.484.320/0001-57	Local : Rua Antônio Zotti
Aprovação: -	Revisão : 00 Prancha : 25	Obra: Pavimentação Asfáltica	Conteúdo: Planta Geométrica

# PERFIL LONGITUDINAL

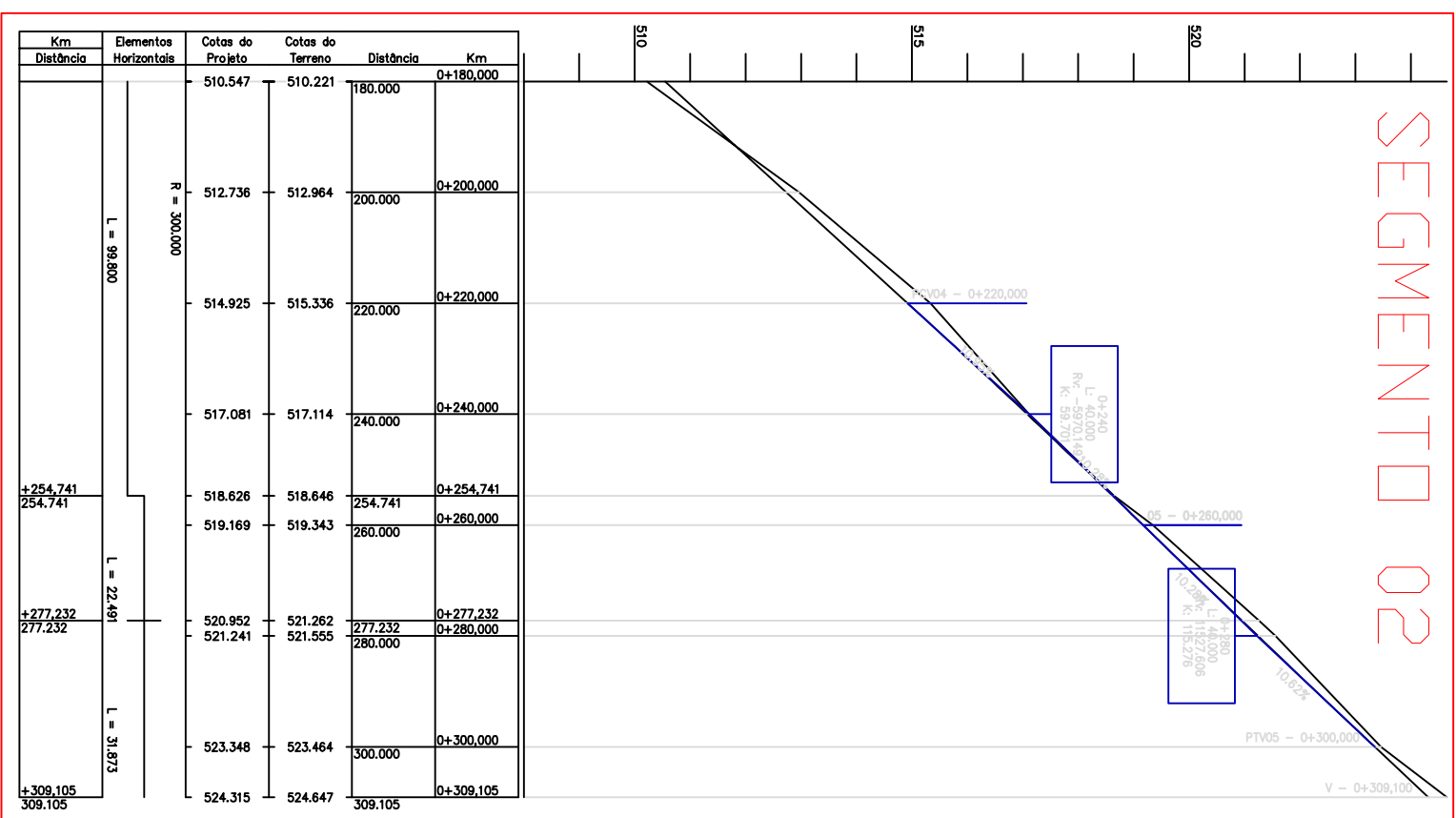
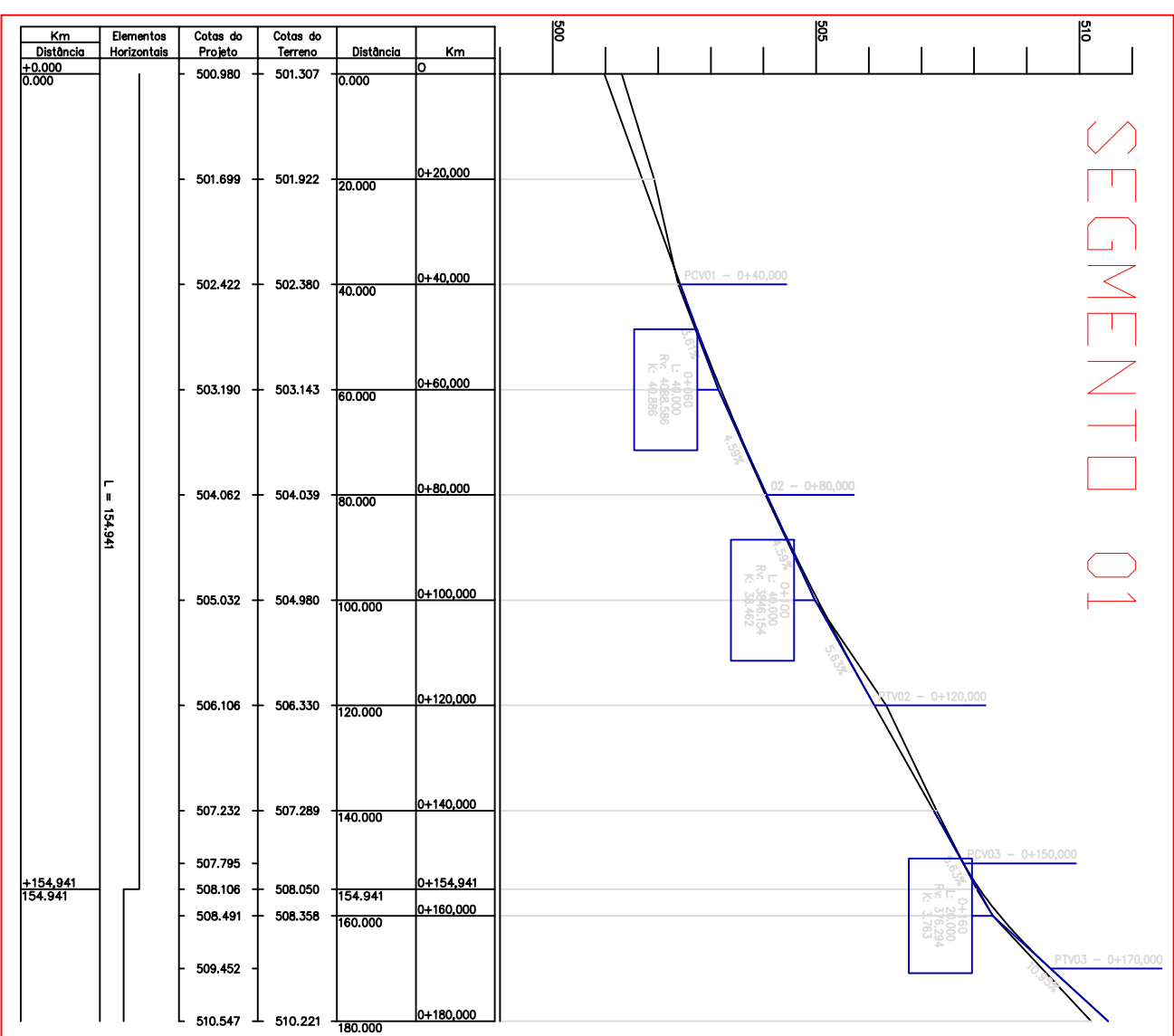
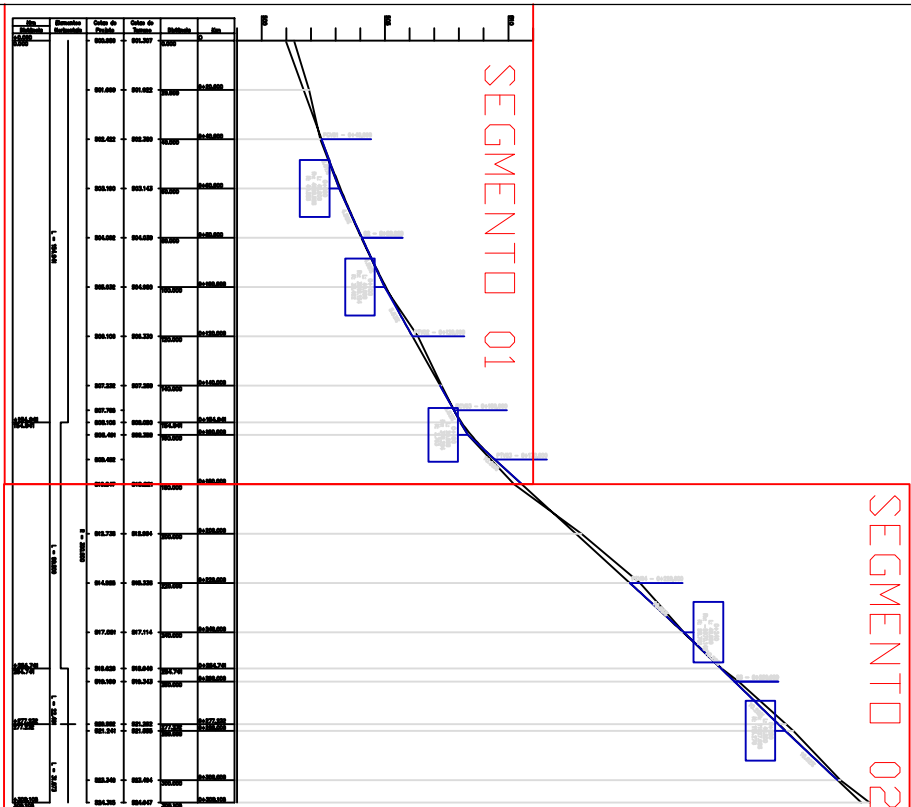

**Projeto :** Lauson Serafini  
**Data :** Novembro/2018  
**Resp. Técnico :** Eng. Civil Lauson Serafini  
**CREA/RS:** 123168-D

**Desenho:** Diego Kichel  
**Escala :** Indicada  
**Cliente:** Pref. Municipal de Tupanci do Sul  
**CNPJ:** 90.484.320/0001-57

**Av. Borges de Medeiros, 615 - Sala 104**  
**Getúlio Vargas - RS - CEP 99900-000**  
**Fone: 54-3341 3753 / 54-99950 5335**

**Revisão :** 00  
**Local :** Rua Antônio Zotti

**Prancha :** 26  
**Conteúdo:** Perfil Longitudinal

Km: 0+100,000  
Cota do terreno: 504,980  
Cota do projeto: 505,052

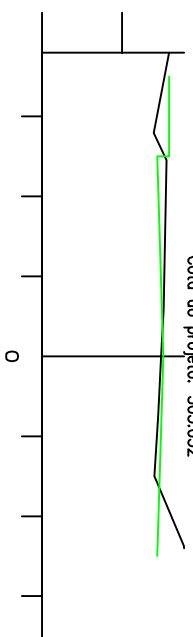

Km: 0+80,000  
Cota do terreno: 504,039  
Cota do projeto: 504,062



Km: 0+60,000  
Cota do terreno: 503,143  
Cota do projeto: 503,190



Km: 0+40,000  
Cota do terreno: 502,380  
Cota do projeto: 502,422



Km: 0+20,000  
Cota do terreno: 501,922  
Cota do projeto: 501,699

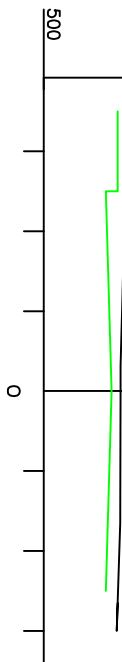

Km: 0  
Cota do terreno: 501,307  
Cota do projeto: 500,980

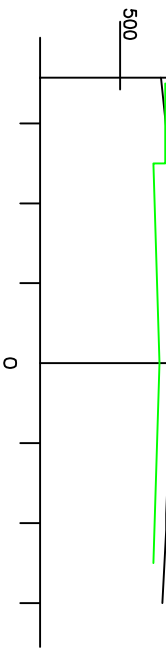

Km: 0+200,000  
Cota do terreno: 512,964  
Cota do projeto: 512,736

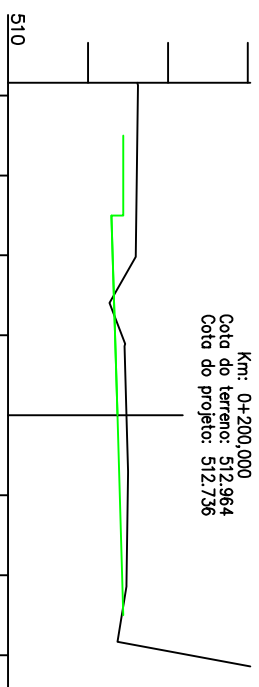

Km: 0+180,000  
Cota do terreno: 510,221  
Cota do projeto: 510,547

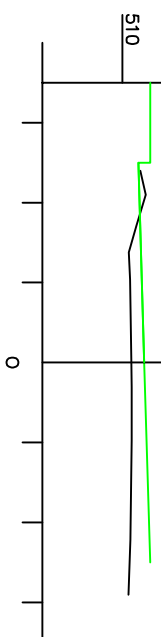

Km: 0+160,000  
Cota do terreno: 508,358  
Cota do projeto: 508,491

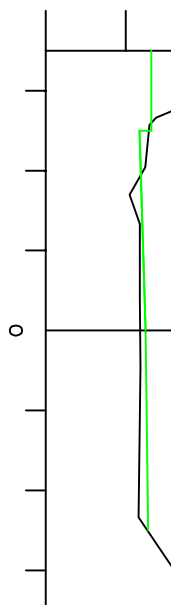

Km: 0+154,941  
Cota do terreno: 508,050  
Cota do projeto: 508,106

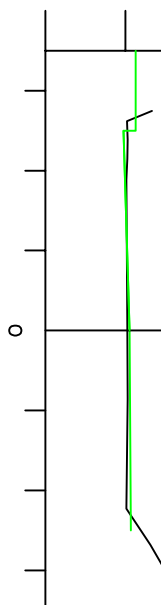

Km: 0+140,000  
Cota do terreno: 507,289  
Cota do projeto: 507,232

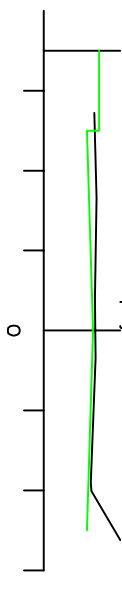

Km: 0+120,000  
Cota do terreno: 506,330  
Cota do projeto: 506,106

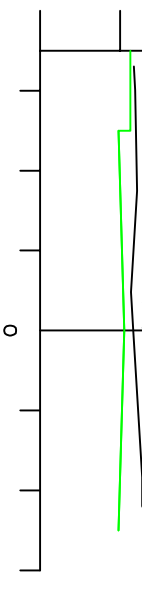

Km: 0+260,000  
Cota do terreno: 519,343  
Cota do projeto: 519,169

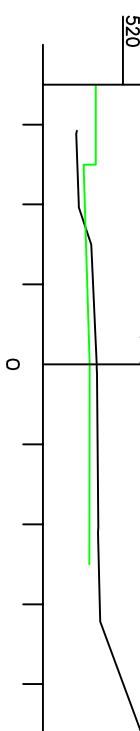

Km: 0+254,741  
Cota do terreno: 518,646  
Cota do projeto: 518,626

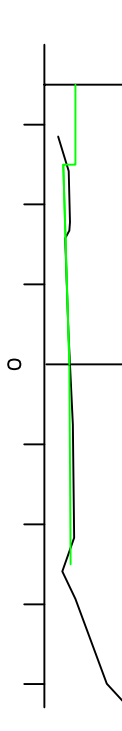

Km: 0+240,000  
Cota do terreno: 517,114  
Cota do projeto: 517,081

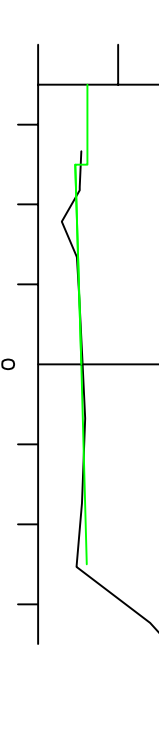

Km: 0+220,000  
Cota do terreno: 515,336  
Cota do projeto: 514,925

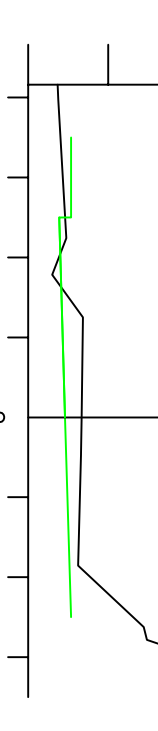

Km: 0+220,000  
Cota do terreno: 515,336  
Cota do projeto: 514,925

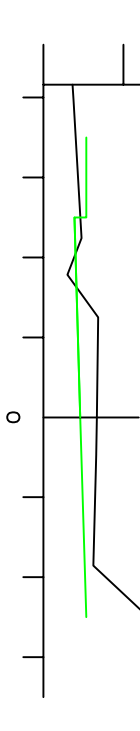

Km: 0+309,105  
Cota do terreno: 524,647

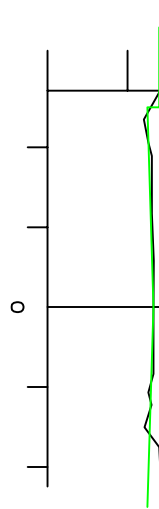

Km: 0+300,000  
Cota do terreno: 523,464  
Cota do projeto: 523,348

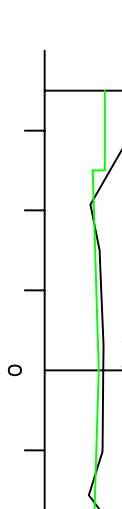

Km: 0+280,000  
Cota do terreno: 521,555  
Cota do projeto: 521,241

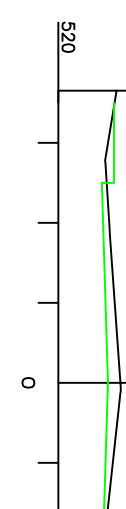

Km: 0+277,232  
Cota do terreno: 521,262  
Cota do projeto: 520,952

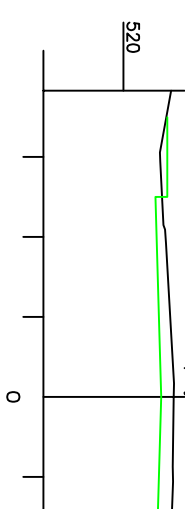

Av. Borges de Medeiros, 615 - Sala 104  
Getúlio Vargas - RS - CEP 99900-000  
Fone: 54-3341 3753 / 54-99950 5335

Projeto :  
Lauson Serafini

Data :  
Novembro/2018

Resp. Técnico:  
.....

Cliente:  
.....

Desenho: Diego Kichel	Escala: Indicada	Resp. Técnico: Eng. Civil Lauson Serafini	CREA/RS 123168-D
Aprovação: -	Revisão: 00	Cliente: Pref. Municipal de Tupanci do Sul	CNPJ: 90.484.320/0001-57
	Prancha: 27	Obra: Pavimentação Asfáltica	
		Local: Rua Antônio Zotti	
		Conteúdo: Seção Transversal	

DETALHE REBAIXAMENTO CALÇADA ACESSIBILIDADE  
SEM ESCALA

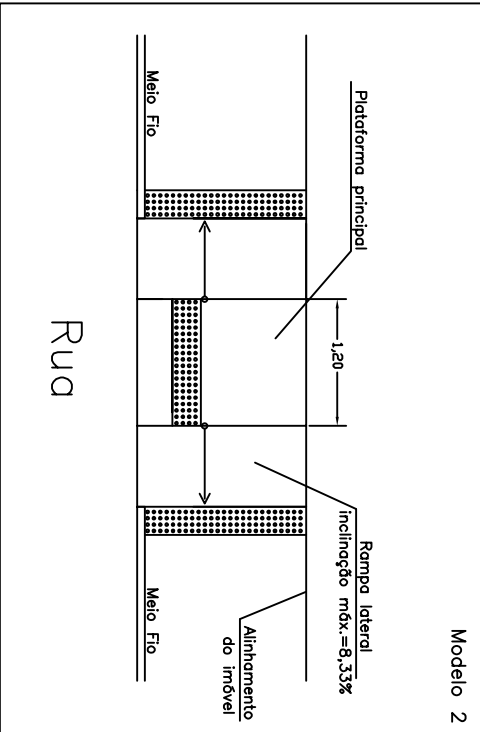
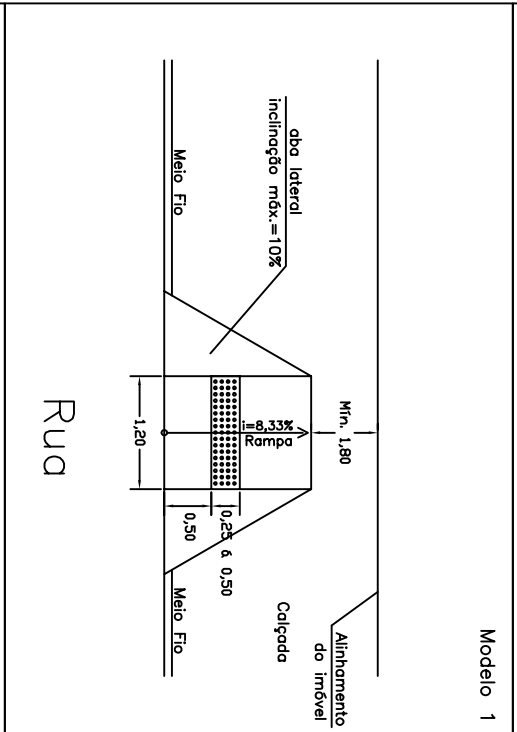

DETALHE FAIXA DE SEGURANÇA  
SEM ESCALA

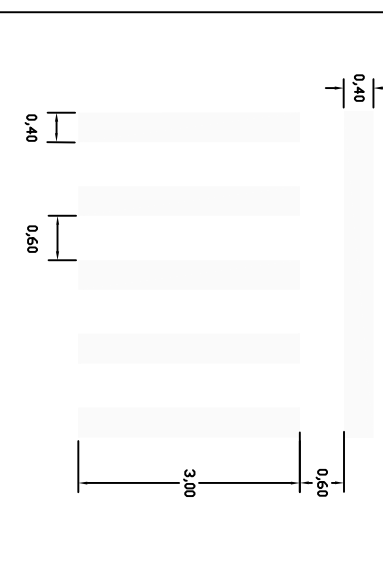

SINAL	CÓDIGO	NOME	QUANTIDADE
	R-19	Velocidade - 40 km/h	01
	A32b	Passagem Sinalizada de Pedestres	08

DETALHE CALÇADA ACESSIBILIDADE  
SEM ESCALA

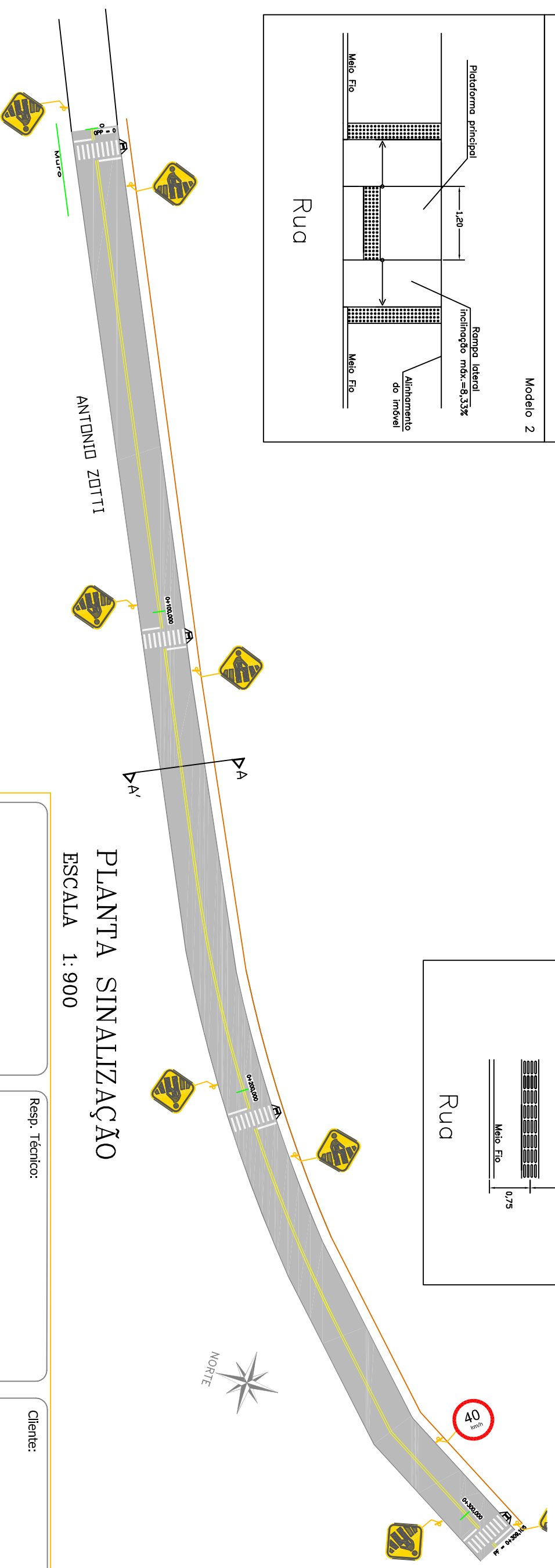
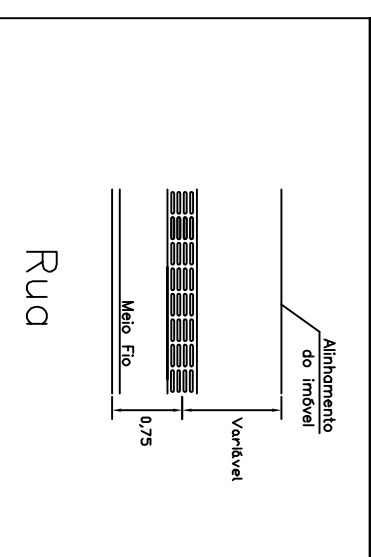

PLANTA SINALIZAÇÃO  
ESCALA 1: 900

Av. Borges de Medeiros, 615 - Sala 104  
Getúlio Vargas - RS - CEP 99900-000  
Fone: 54-3341 3753 / 54-99950 5335

Resp. Técnico:  
.....

Cliente:  
.....

Projeto : Lauson Serafini	Data : Novembro/2018	Resp. Técnico : Eng. Civil Lauson Serafini	CREA/RS 123168-D
Desenho: Diego Kichel	Escala : Indicada	Cliente: Pref. Municipal de Tupanci do Sul	CNPJ: 90.484.320/0001-57
Aprovação: -	Revisão : 00	Local : Rua Antônio Zotti	
	Prancha : 23	Conteúdo: Planta de Sinalização	

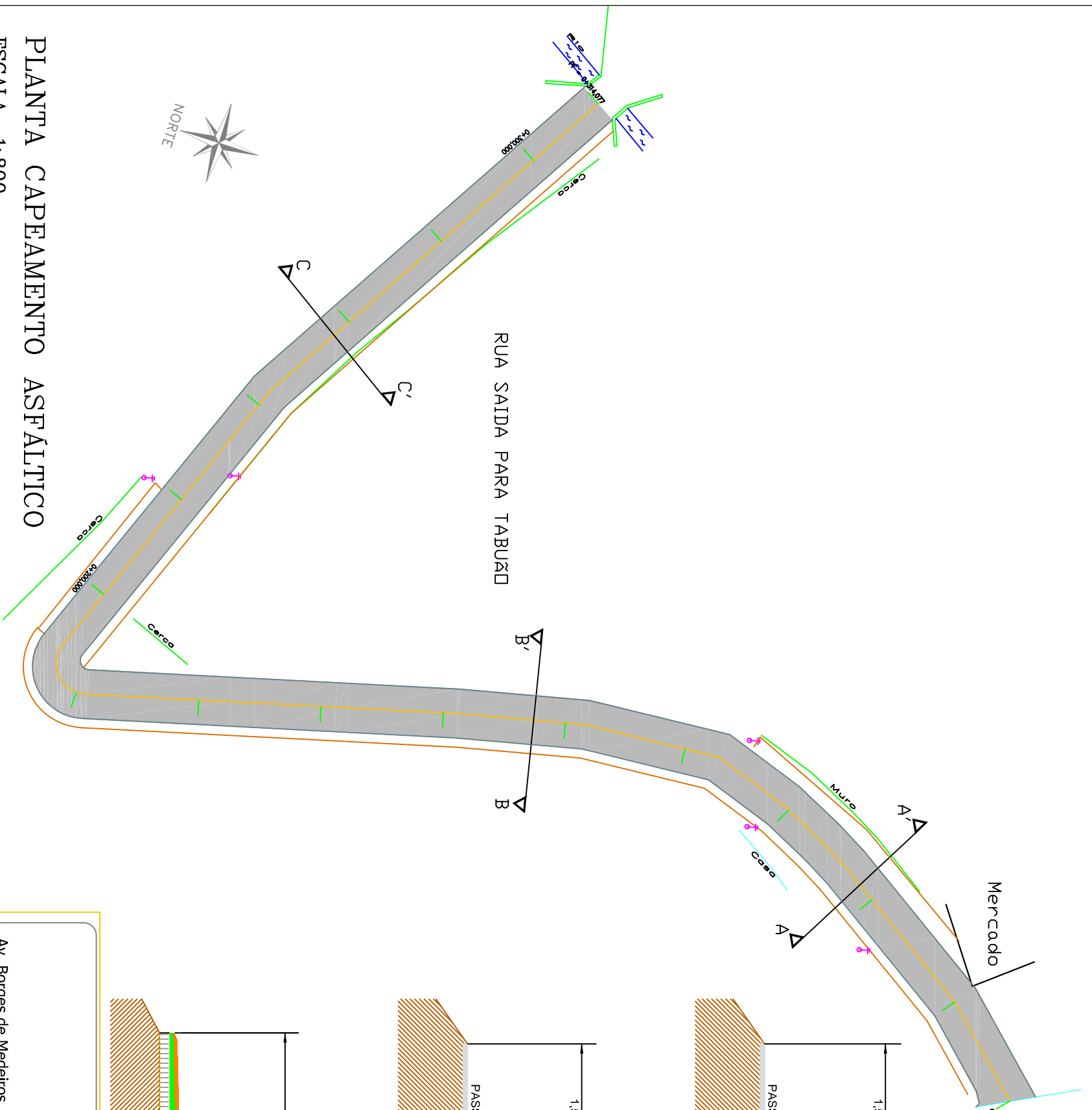

# PLANTA CAPEAMENTO ASFÁLTICO

ESCALA 1: 800

## DETALHE DA IMPLANTAÇÃO REVESTIMENTO ASFÁLTICO

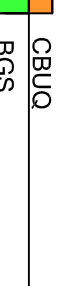
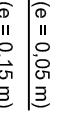
	CBUQ	(e = 0,05 m)
	BGS	(e = 0,15 m)
	Macadame Seco	(e = 0,20 m)

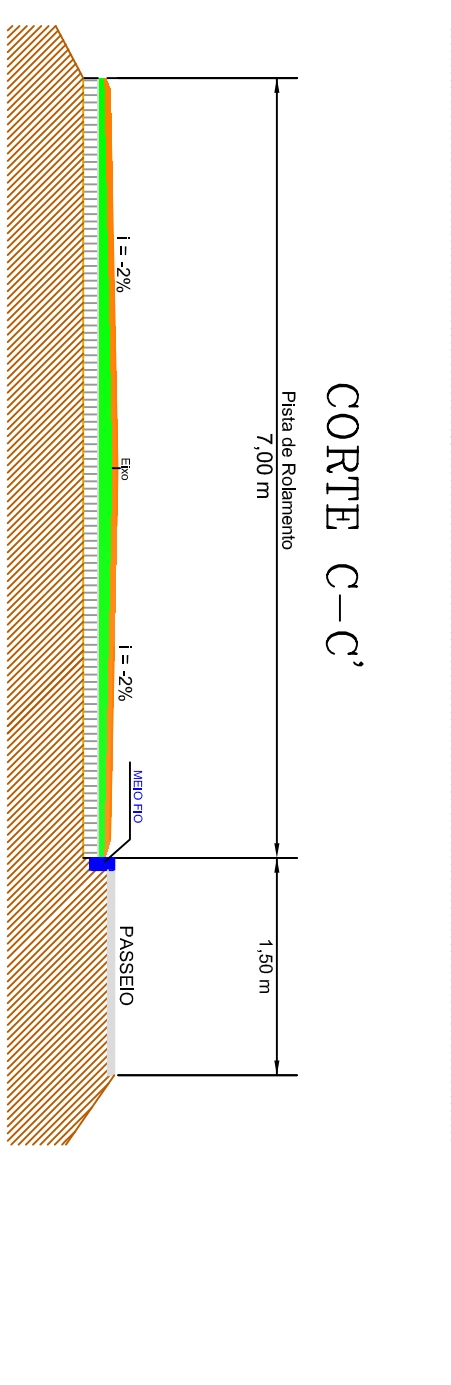
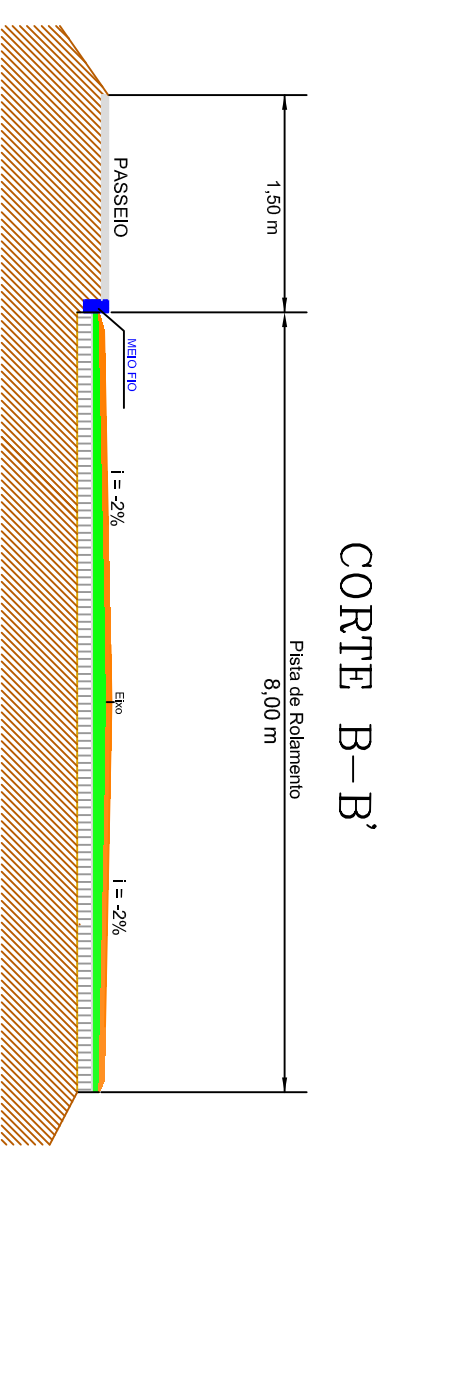
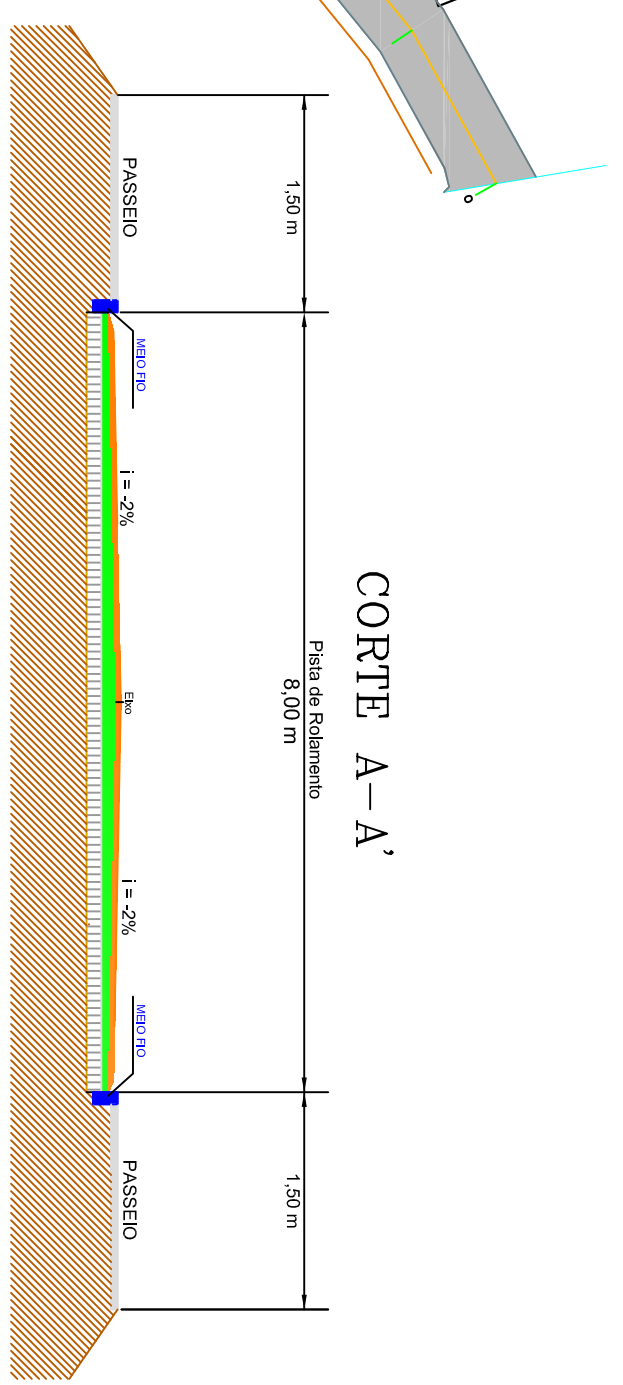

Projeto : <b>Lauson Serafini</b>		Data : <b>Novembro/2018</b>		Resp. Técnico: .....		Cliente: .....	
Desenho: <b>Diego Kichel</b>		Escala : <b>Indicada</b>		Resp. Técnico : <b>Eng. Civil Lauson Serafini</b>		CREA/RS 123168-D	
Av. Borges de Medeiros, 615 - Sala 104 Getúlio Vargas - RS - CEP 99900-000 Fone: 54-3341 3753 / 54-99950 5335		Cliente: <b>Pref. Municipal de Tupanci do Sul</b>		CNPJ: 90.484.320/0001-57		Local : <b>Estrada Saída Para Taboão</b>	
Aprovação: -		Revisão : <b>00</b>		Prancha : <b>11</b>		Conteúdo: <b>Planta de Capejamento Asfáltico</b>	

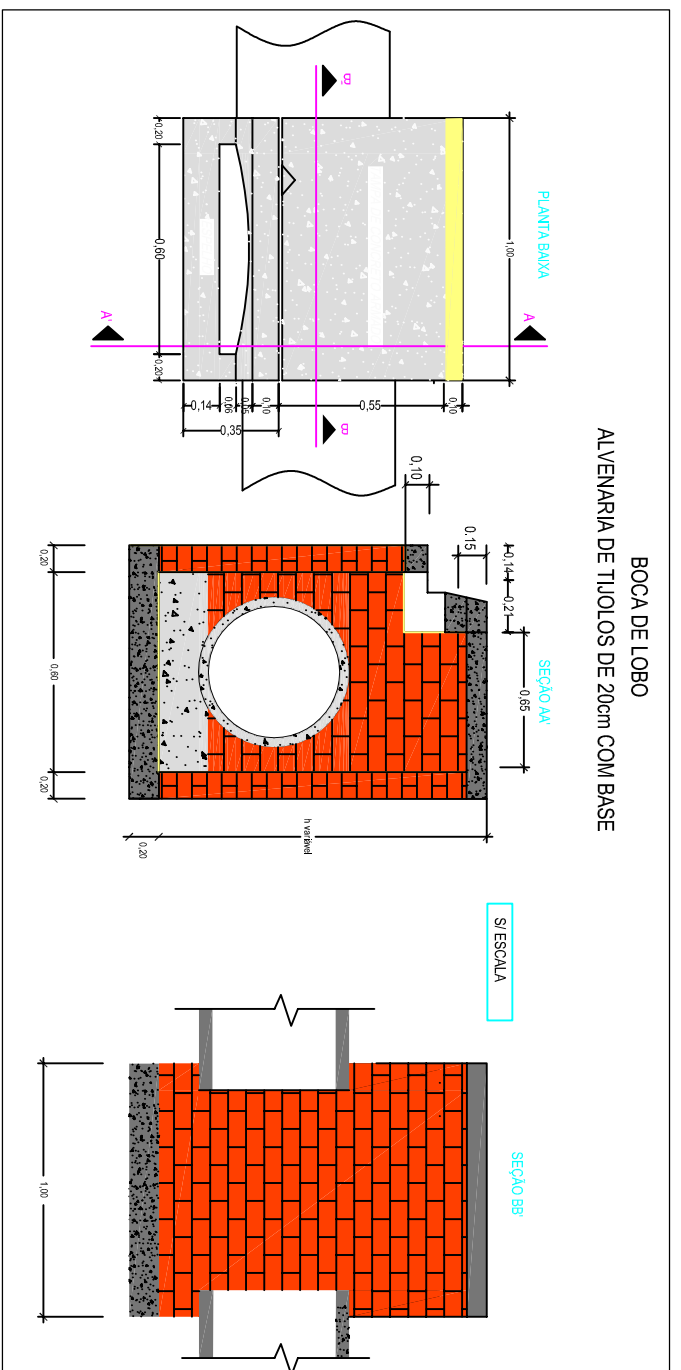

BOCA DE LOBO  
ALVENARIA DE TIJOLOS DE 20cm COM BASE

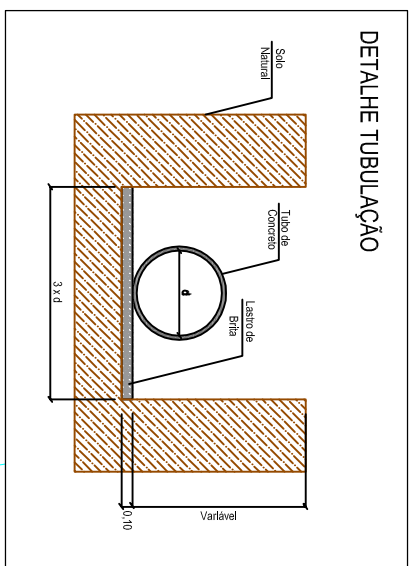

DETALHE TUBULAÇÃO

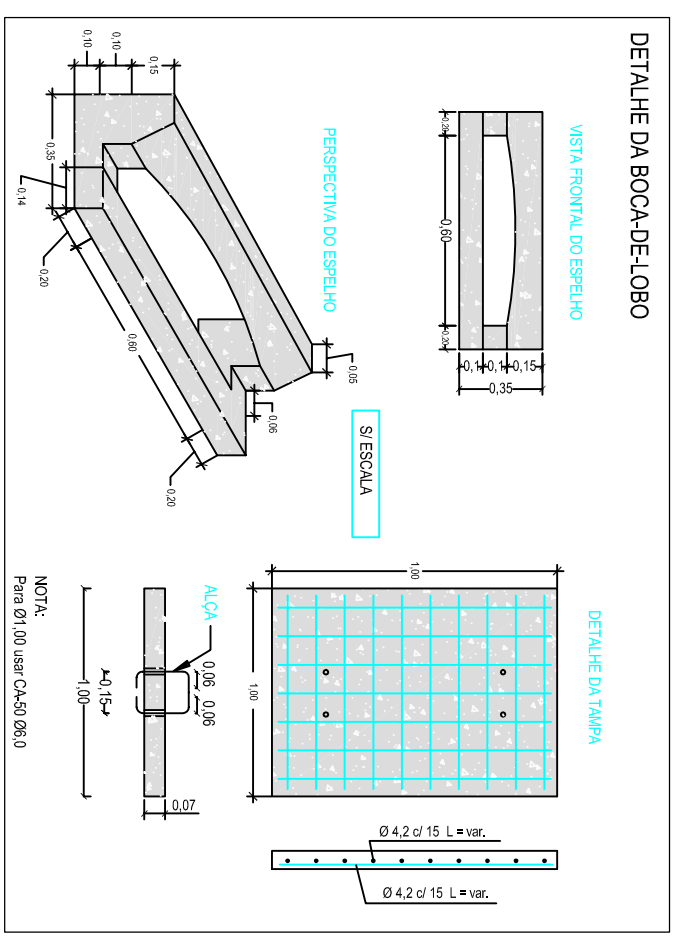

DETALHE DA BOCA-DE-LOBO

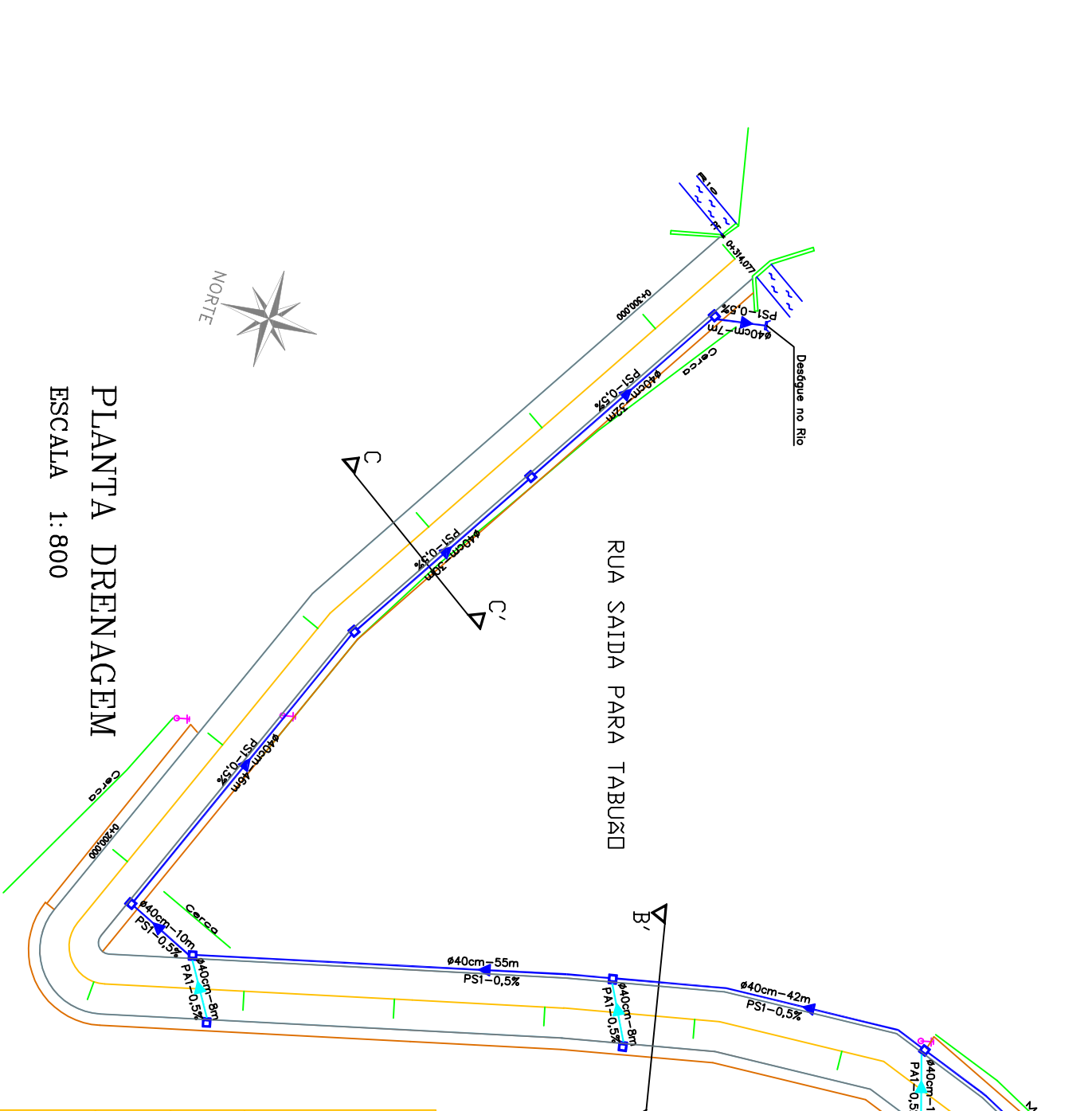

RUA SAÍDA PARA TABUÃO

PLANTA DRENAGEM  
ESCALA 1: 800

**LEGENDA:**

- Caixa de Inspeção – Existente
- Boca de Lobo – Existente
- Boca de Lobo – Projetada
- Caixa de Inspeção – Projetada
- Tubo de Concreto Simples – PS1
- Tubo de Concreto Armado – PA1
- Meio Fio de Concreto
- Ala

Projeto : <b>Lauson Serafini</b>		Data : <b>Novembro/2018</b>		Resp. Técnico: .....	
Desenho: <b>Diego Kichel</b>		Escala : <b>Indicada</b>		Cliente: .....	
Av. Borges de Medeiros, 615 - Sala 104 Getúlio Vargas - RS - CEP 99900-000 Fone: 54-3341 3753 / 54-99950 5335		Resp. Técnico : <b>Eng. Civil Lauson Serafini</b>		CREA/RS 123168-D	
Aprovação: -		Revisão : <b>00</b>		Local : <b>Estrada Saída Para Taboão</b>	
Prancha : <b>13</b>		Obra: <b>Pavimentação Asfáltica</b>		Conteúdo: <b>Planta de Drenagem Pluvial</b>	
Cliente: <b>Pref. Municipal de Tupanci do Sul</b>		CNPJ: 90.484.320/0001-57		.....	



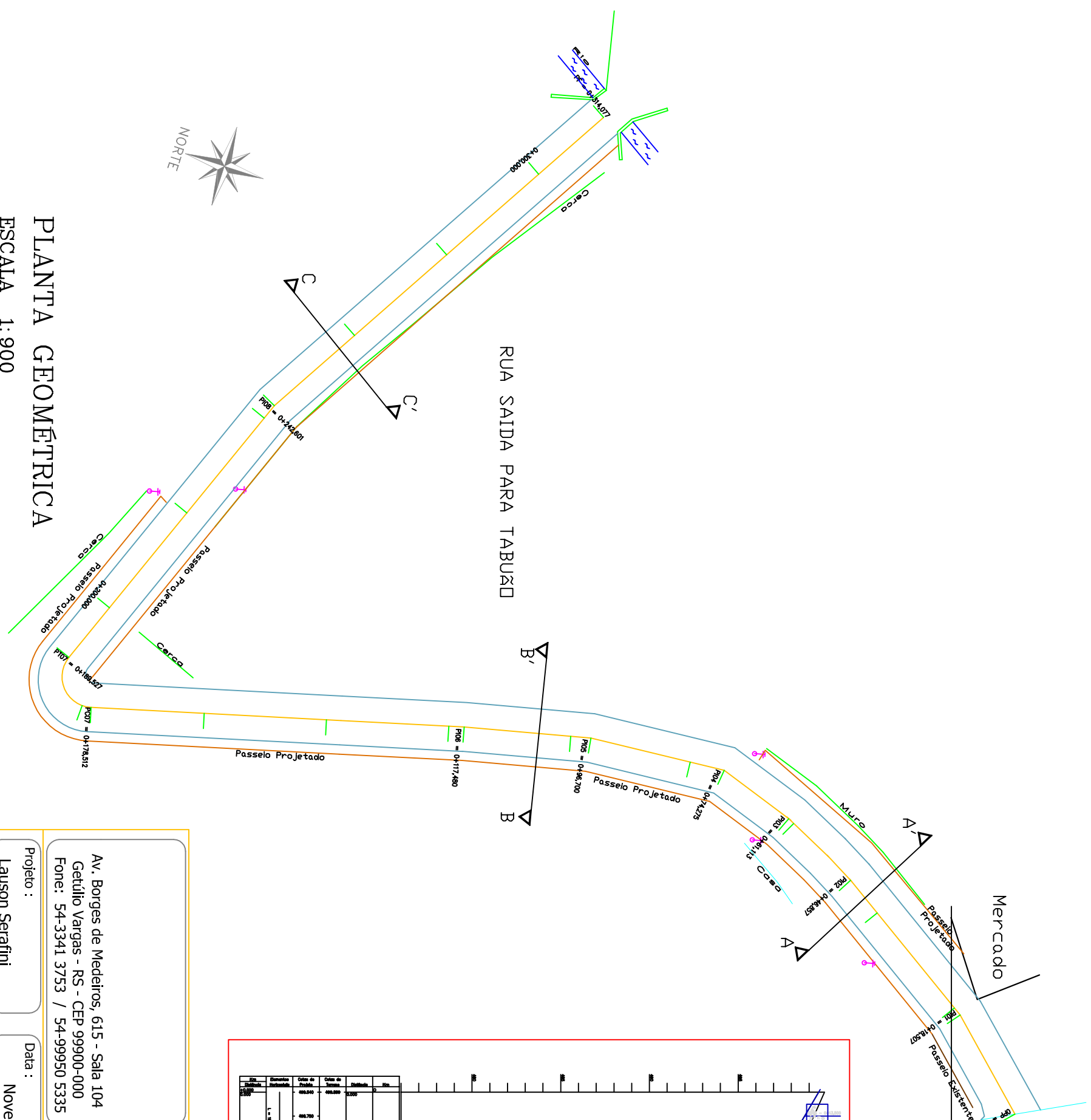

**PLANTA GEOMÉTRICA**  
**ESCALA 1:900**



Estação	Projeto	Terreno	Altura	Distância	Área	Volume	Observações
0+000	0+000	0+000	0+000	0+000	0+000	0+000	
0+005	0+005	0+005	0+005	0+005	0+005	0+005	
0+010	0+010	0+010	0+010	0+010	0+010	0+010	
0+015	0+015	0+015	0+015	0+015	0+015	0+015	
0+020	0+020	0+020	0+020	0+020	0+020	0+020	
0+025	0+025	0+025	0+025	0+025	0+025	0+025	
0+030	0+030	0+030	0+030	0+030	0+030	0+030	
0+035	0+035	0+035	0+035	0+035	0+035	0+035	
0+040	0+040	0+040	0+040	0+040	0+040	0+040	
0+045	0+045	0+045	0+045	0+045	0+045	0+045	
0+050	0+050	0+050	0+050	0+050	0+050	0+050	
0+055	0+055	0+055	0+055	0+055	0+055	0+055	
0+060	0+060	0+060	0+060	0+060	0+060	0+060	
0+065	0+065	0+065	0+065	0+065	0+065	0+065	
0+070	0+070	0+070	0+070	0+070	0+070	0+070	
0+075	0+075	0+075	0+075	0+075	0+075	0+075	
0+080	0+080	0+080	0+080	0+080	0+080	0+080	
0+085	0+085	0+085	0+085	0+085	0+085	0+085	
0+090	0+090	0+090	0+090	0+090	0+090	0+090	
0+095	0+095	0+095	0+095	0+095	0+095	0+095	
0+100	0+100	0+100	0+100	0+100	0+100	0+100	
0+105	0+105	0+105	0+105	0+105	0+105	0+105	
0+110	0+110	0+110	0+110	0+110	0+110	0+110	
0+115	0+115	0+115	0+115	0+115	0+115	0+115	
0+120	0+120	0+120	0+120	0+120	0+120	0+120	
0+125	0+125	0+125	0+125	0+125	0+125	0+125	
0+130	0+130	0+130	0+130	0+130	0+130	0+130	
0+135	0+135	0+135	0+135	0+135	0+135	0+135	
0+140	0+140	0+140	0+140	0+140	0+140	0+140	
0+145	0+145	0+145	0+145	0+145	0+145	0+145	
0+150	0+150	0+150	0+150	0+150	0+150	0+150	
0+155	0+155	0+155	0+155	0+155	0+155	0+155	
0+160	0+160	0+160	0+160	0+160	0+160	0+160	
0+165	0+165	0+165	0+165	0+165	0+165	0+165	
0+170	0+170	0+170	0+170	0+170	0+170	0+170	
0+175	0+175	0+175	0+175	0+175	0+175	0+175	
0+180	0+180	0+180	0+180	0+180	0+180	0+180	
0+185	0+185	0+185	0+185	0+185	0+185	0+185	
0+190	0+190	0+190	0+190	0+190	0+190	0+190	
0+195	0+195	0+195	0+195	0+195	0+195	0+195	
0+200	0+200	0+200	0+200	0+200	0+200	0+200	

Projeto : <b>Lauson Serafini</b>		Data : <b>Novembro/2018</b>		Resp. Técnico: .....		Cliente: .....	
Desenho: <b>Diego Kichel</b>		Escala : <b>Indicada</b>		Resp. Técnico : <b>Eng. Civil Lauson Serafini</b>		CREA/RS 123168-D	
Aprovação: -		Revisão : <b>00</b>		Cliente: <b>Pref. Municipal de Tupanci do Sul</b>		CNPJ: 90.484.320/0001-57	
Prancha : <b>14</b>		Local : <b>Estrada Saída Para Taboão</b>		Obra: <b>Pavimentação Asfáltica</b>		Conteúdo: <b>Planta Geométrica</b>	
Av. Borges de Medeiros, 615 - Sala 104 Getúlio Vargas - RS - CEP 99900-000 Fone: 54-3341 3753 / 54-99950 5335							

# SEGMENTO 01

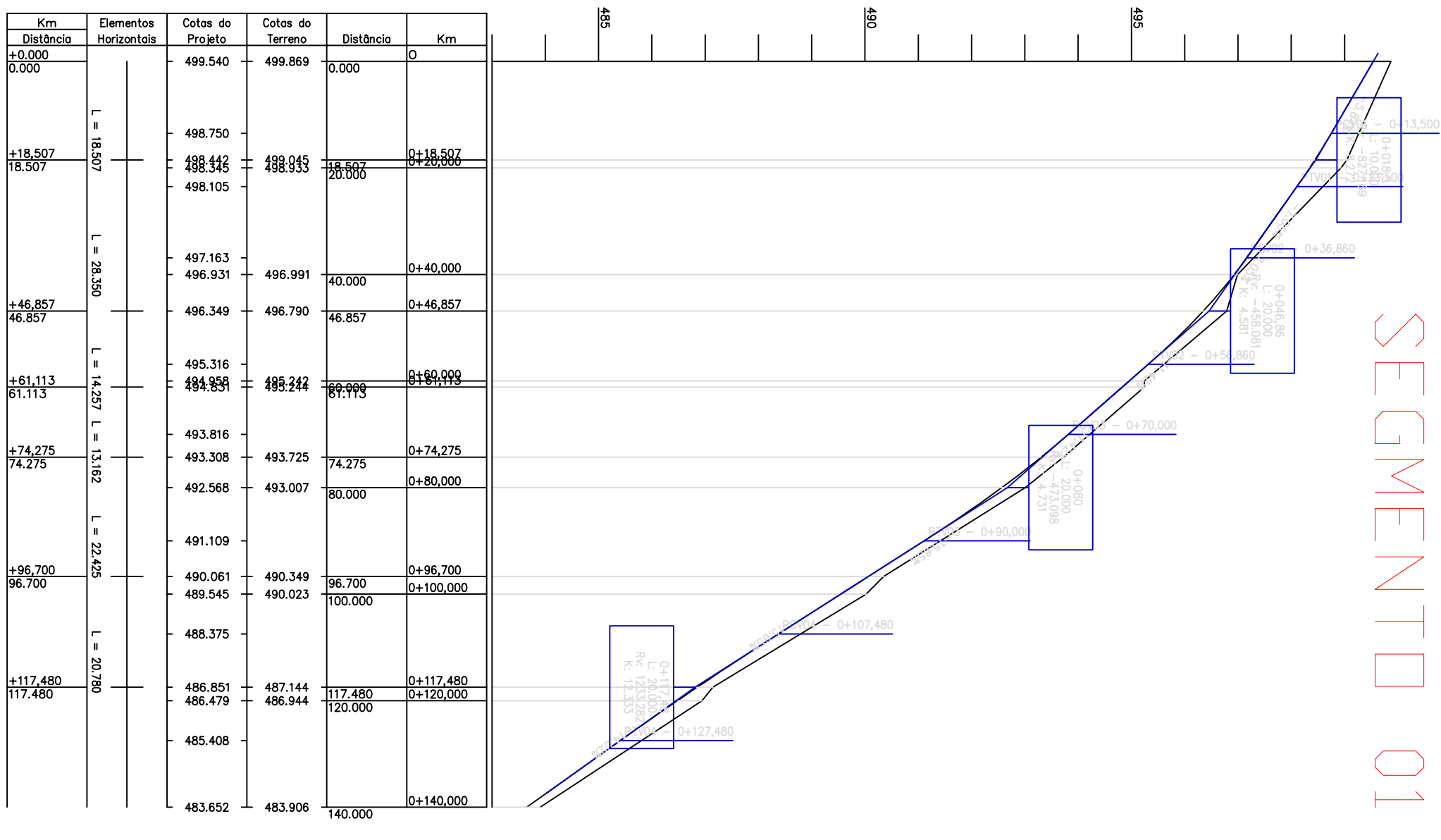

# SEGMENTO 02

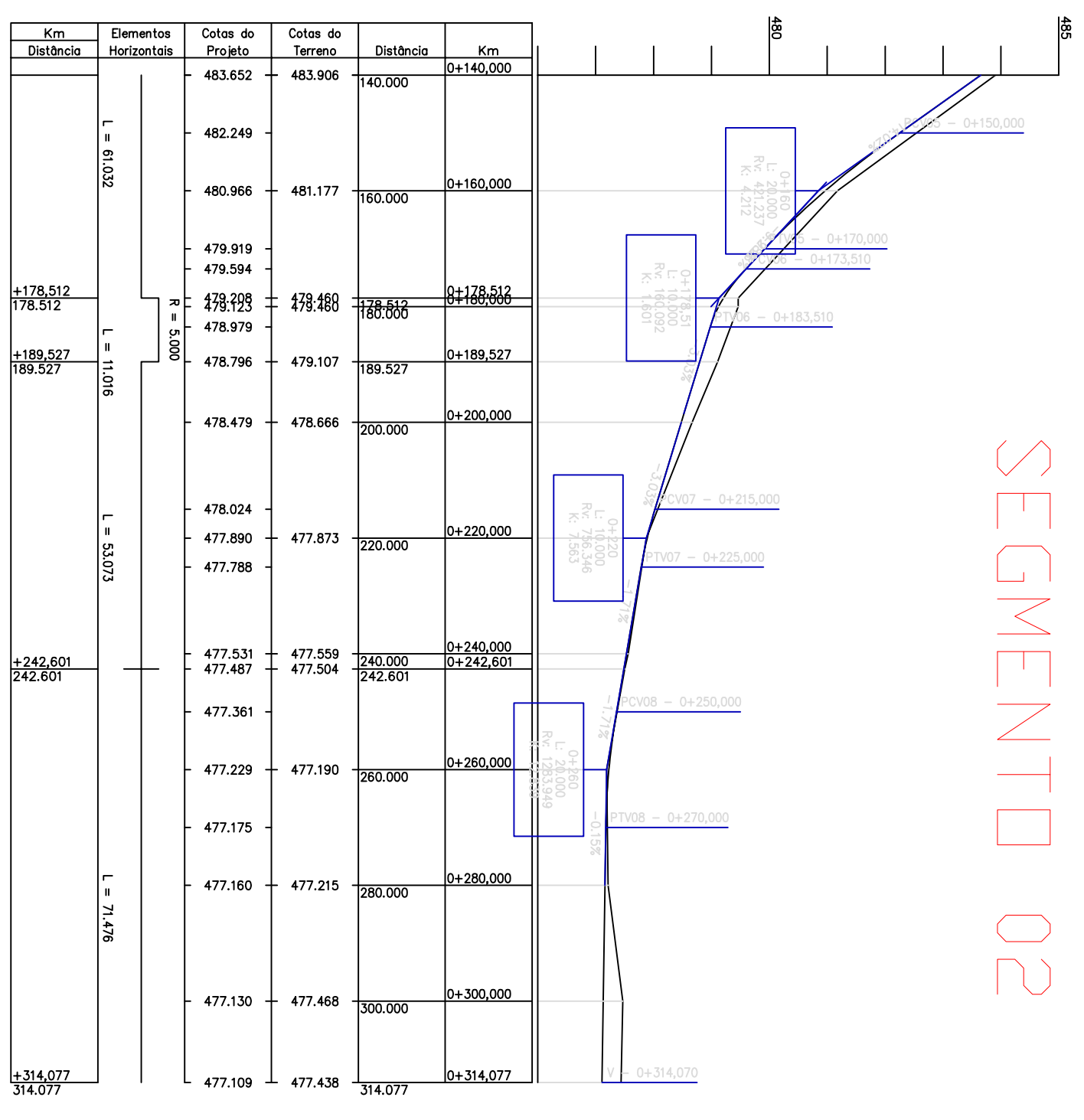

<b>Projeto:</b> Lauson Serafini		<b>Data:</b> Novembro/2018		<b>Resp. Técnico:</b> .....	
<b>Desenho:</b> Diego Kichel		<b>Escala:</b> Indicada		<b>Ciente:</b> .....	
<b>Av. Borges de Medeiros, 615 - Sala 104</b> <b>Getúlio Vargas - RS - CEP 99900-000</b> <b>Fone: 54-3341 3753 / 54-99950 5335</b>		<b>Projeto:</b> Eng. Civil Lauson Serafini		<b>CREA/RS 123168-D</b>	
<b>Av. Borges de Medeiros, 615 - Sala 104</b> <b>Getúlio Vargas - RS - CEP 99900-000</b> <b>Fone: 54-3341 3753 / 54-99950 5335</b>		<b>Cliente:</b> Pref. Municipal de Tupanci do Sul		<b>CNPJ:</b> 90.484.320/0001-57	
<b>Projeto:</b> Lauson Serafini		<b>Obra:</b> Pavimentação Asfáltica		<b>Local:</b> Estrada Saída Para Taboão	
<b>Revisão:</b> 00		<b>Prancha:</b> 15		<b>Conteúdo:</b> Perfil Longitudinal	

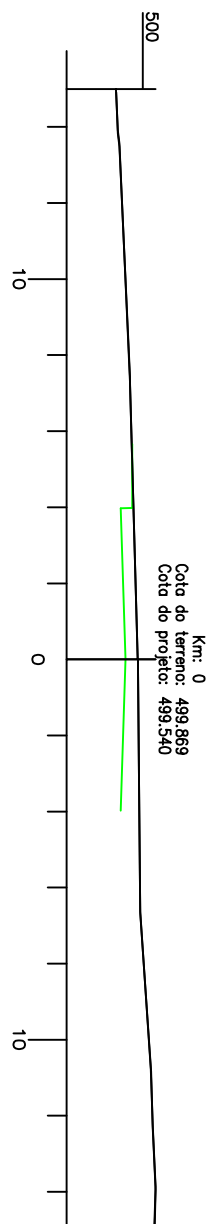
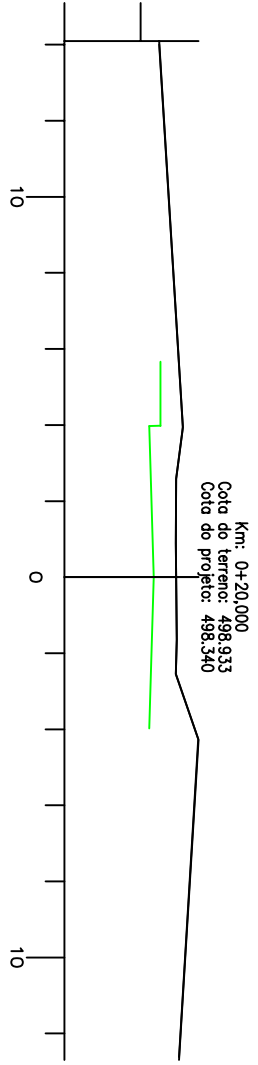
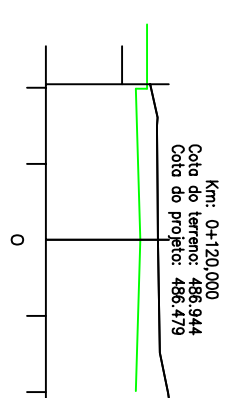
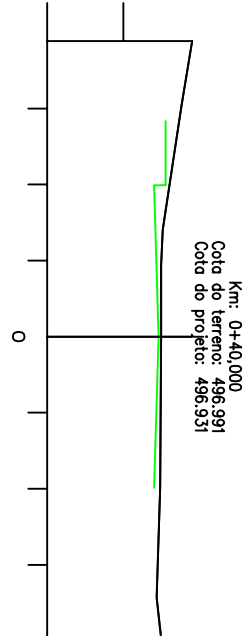
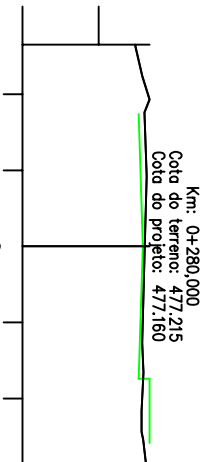
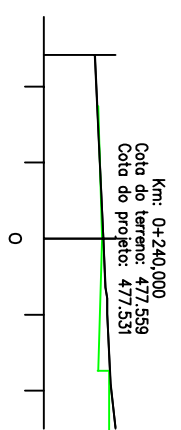
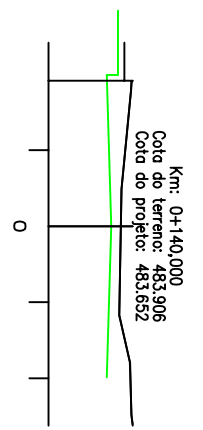
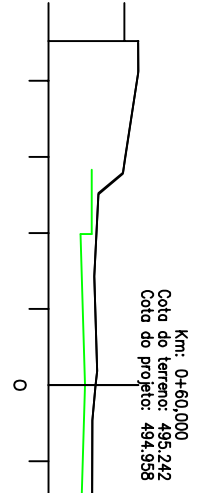
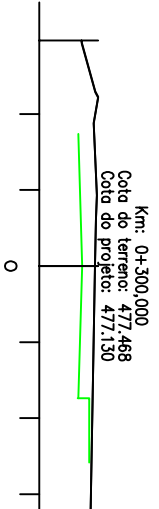
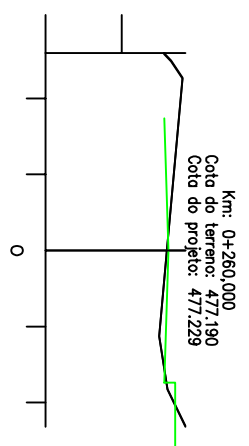
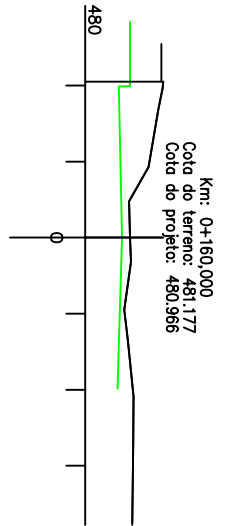
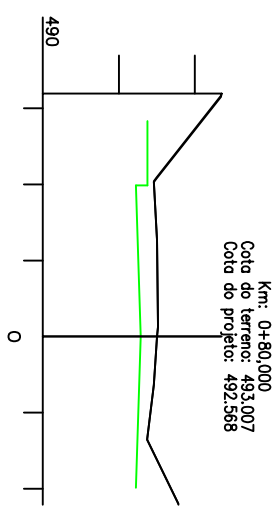
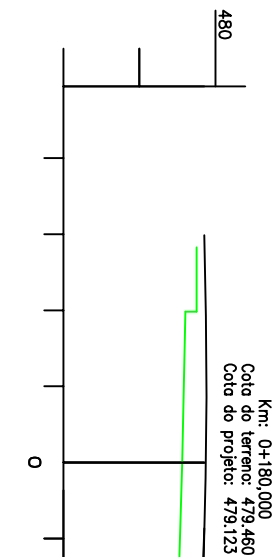
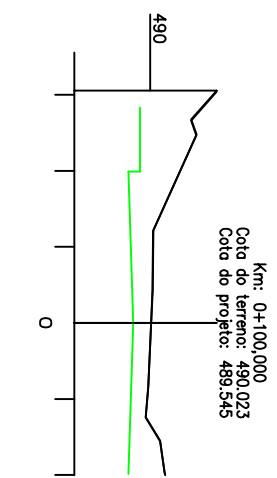

Resp. Técnico:

Cliente:

Av. Borges de Medeiros, 615 - Sala 104  
Getúlio Vargas - RS - CEP 99900-000  
Fone: 54-3341 3753 / 54-99950 5335

.....

.....

Projeto : Lauson Serafini

Resp. Técnico : Eng. Civil Lauson Serafini CREA/RS 123168-D

Desenho: Diego Kichel

Cliente: Pref. Municipal de Tupanci do Sul CNPJ: 90.484.320/0001-57

Aprovação: -

Local : Estrada Saída Para Taboão

Revisão : 16

Conteúdo: Seção Transversal

Prancha : 06

SINAL	CÓDIGO	NOME	QUANTIDADE
	R-1	Parê	01
	R-19	Velocidade - 40 km/h	01
	A-1a	Curva Acentuada à Esquerda	01
	A-1b	Curva Acentuada à Direita	01
	A32b	Passagem Sinalizada de Pedestres	03
<b>PLACA DE NOME DE RUA DUAS FACES</b>			
A = Av. Luiz Parissson			
B = Saída Taboão			01

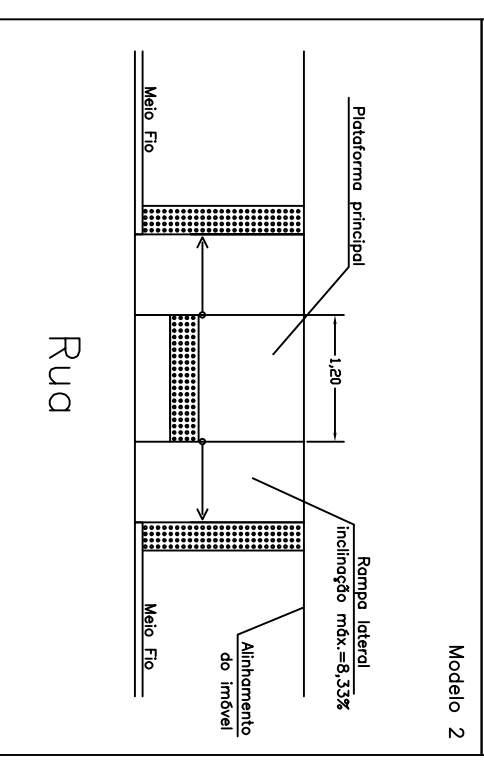
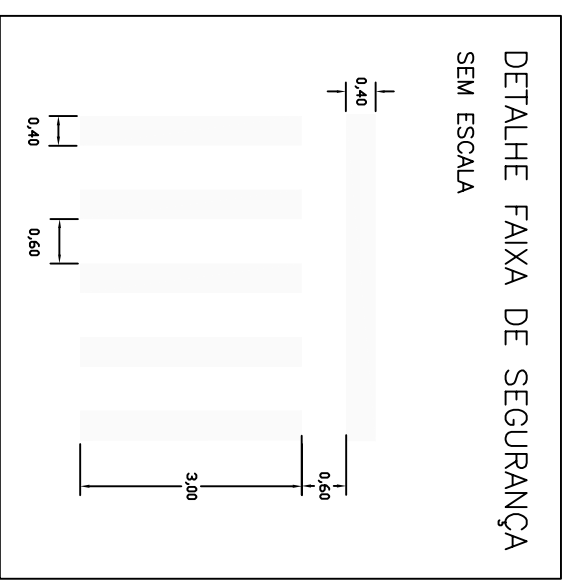
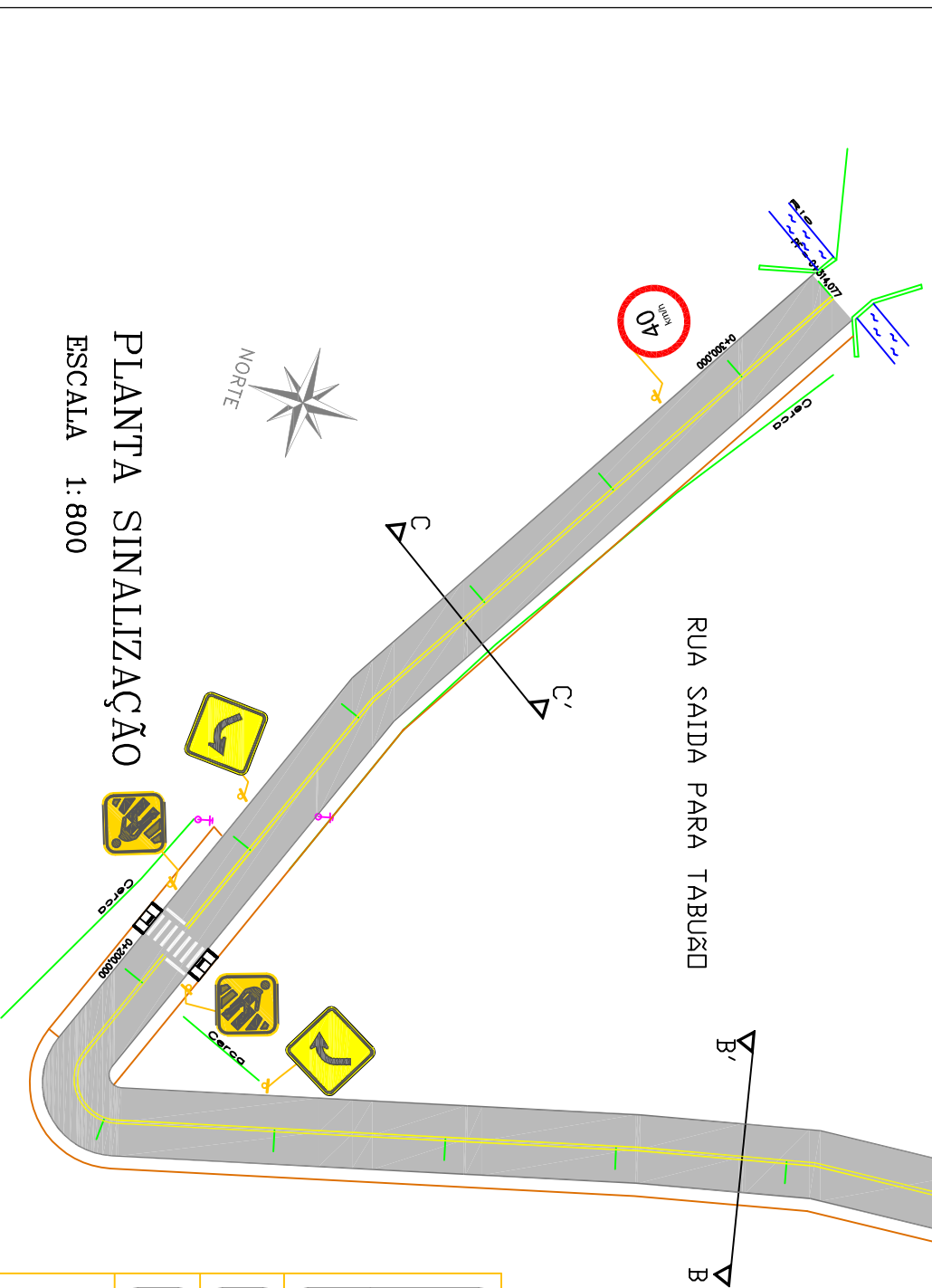
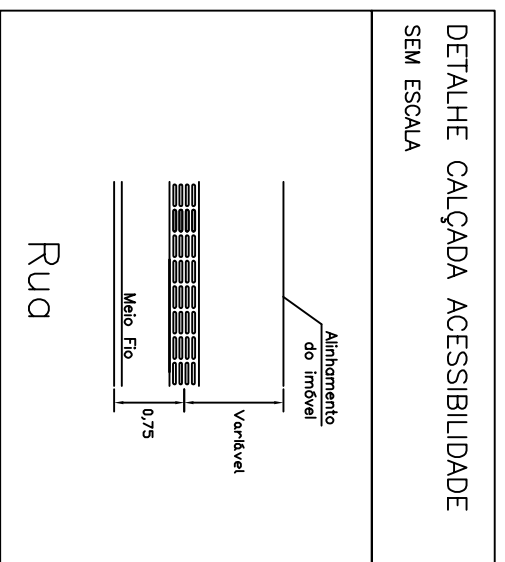

Av. Borges de Medeiros, 615 - Sala 104 Getúlio Vargas - RS - CEP 99900-000 Fone: 54-3341 3753 / 54-99950 5335		Resp. Técnico: .....	Cliente: .....
Projeto : Lauson Serafini	Data : Novembro/2018	Resp. Técnico : Eng. Civil Lauson Serafini      CREA/RS 123168-D	
Desenho: Diego Kichel	Escala : Indicada	Cliente: Pref. Municipal de Tupanci do Sul      CNPJ: 90.484.320/0001-57	Local : Estrada Saída Para Taboão
Aprovação: -	Revisão : 00	Prancha : 12	Conteúdo: Planta de Sinalização

PLANTA SINALIZAÇÃO  
ESCALA 1:800



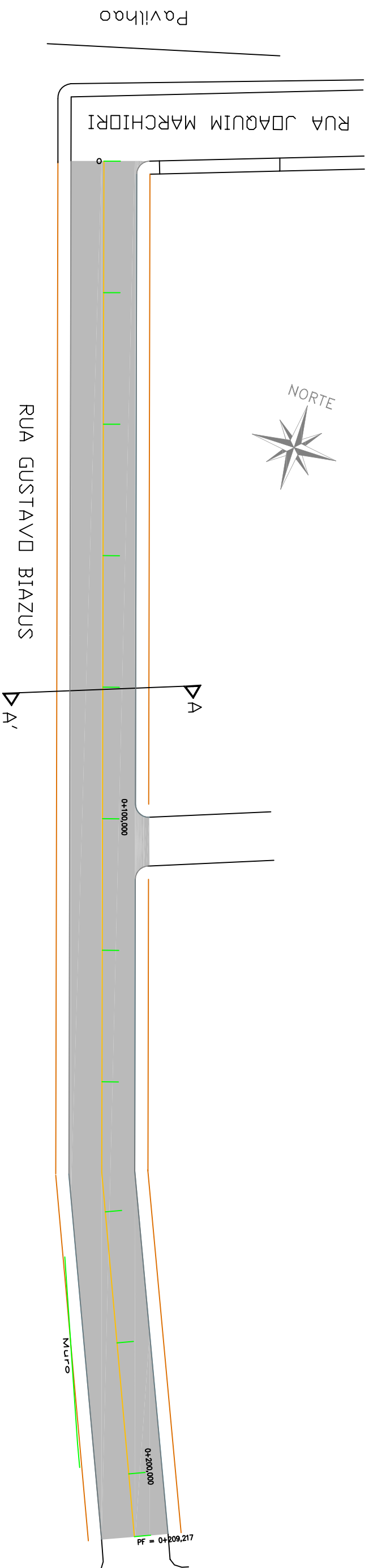

# PLANTA CAPEAMENTO ASFALTICO

ESCALA 1:650

## CORTE A-A'

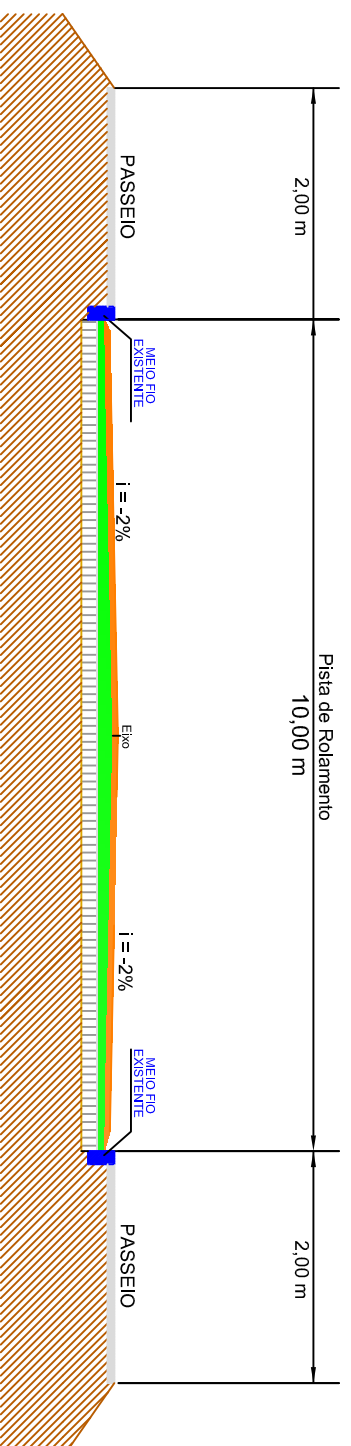

### DETALHE DA IMPLANTAÇÃO REVESTIMENTO ASFALTICO

	CBUQ	(e = 0,05 m)
	BGS	(e = 0,12 m)
	Macadame Seco	(e = 0,16 m)

Av. Borges de Medeiros, 615 - Sala 104 Getúlio Vargas - RS - CEP 99900-000 Fone: 54-3341 3753 / 54-99950 5335		Resp. Técnico: .....	Cliente: .....
Projeto : <b>Lauson Serafini</b>	Data : <b>Novembro/2018</b>	Resp. Técnico : <b>Eng. Civil Lauson Serafini</b> CREA/RS 123168-D	
Desenho: <b>Diego Kichel</b>	Escala : <b>Indicada</b>	Cliente: <b>Pref. Municipal de Tupanci do Sul</b> CNPJ: 90.484.320/0001-57	Local : <b>Rua Gustavo Biazus</b>
Aprovação: -	Revisão : <b>00</b>	Obra: <b>Pavimentação Asfáltica</b>	Conteúdo: <b>Planta de Capçamento Asfáltico</b>
Prancha : <b>06</b>		Conteúdo: <b>Planta de Capçamento Asfáltico</b>	

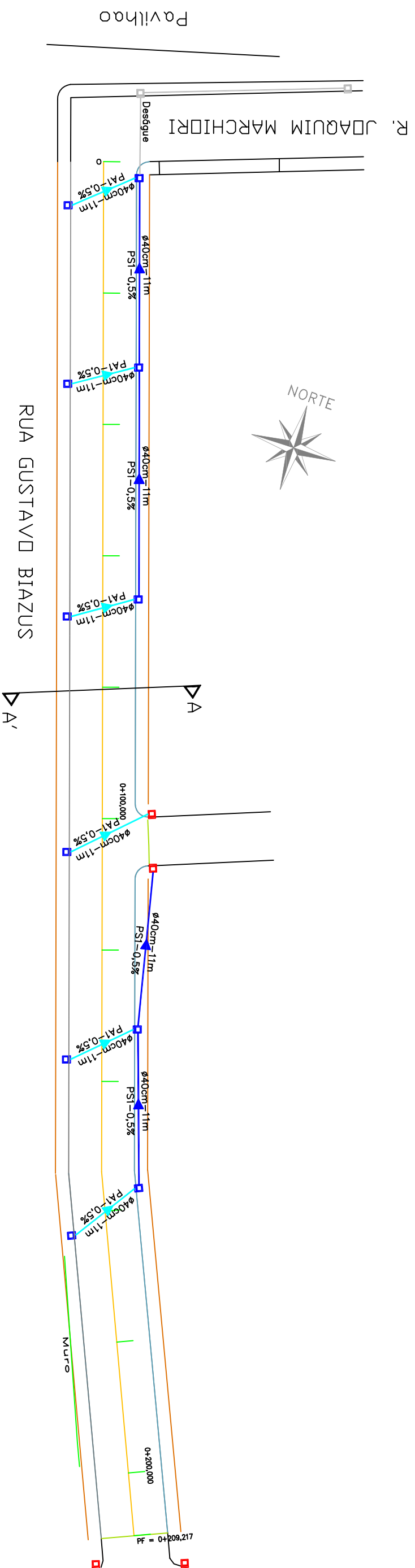
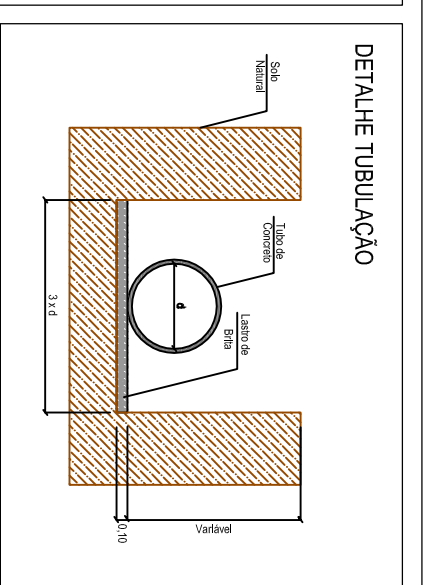
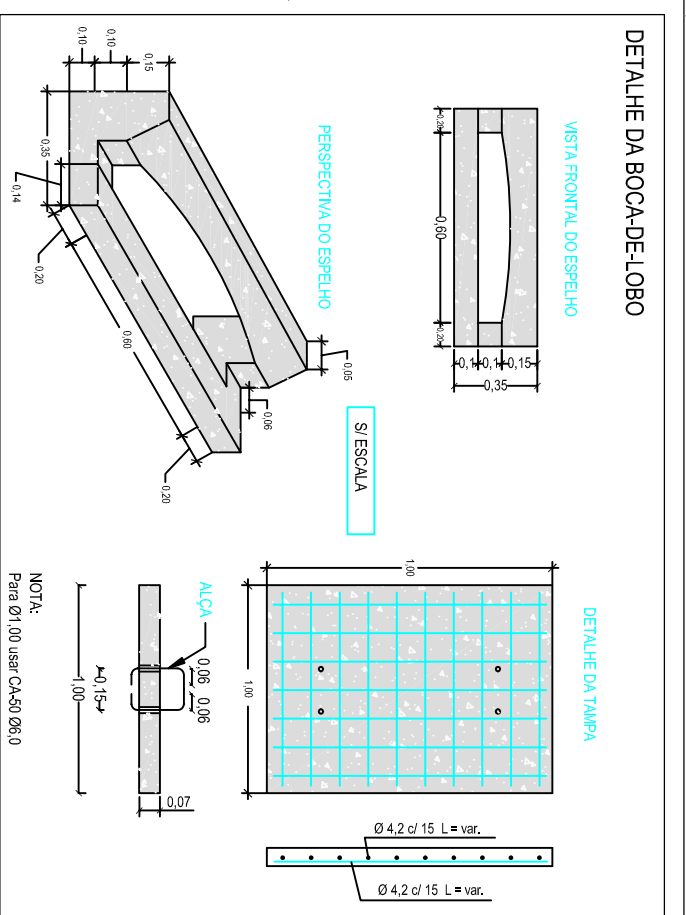
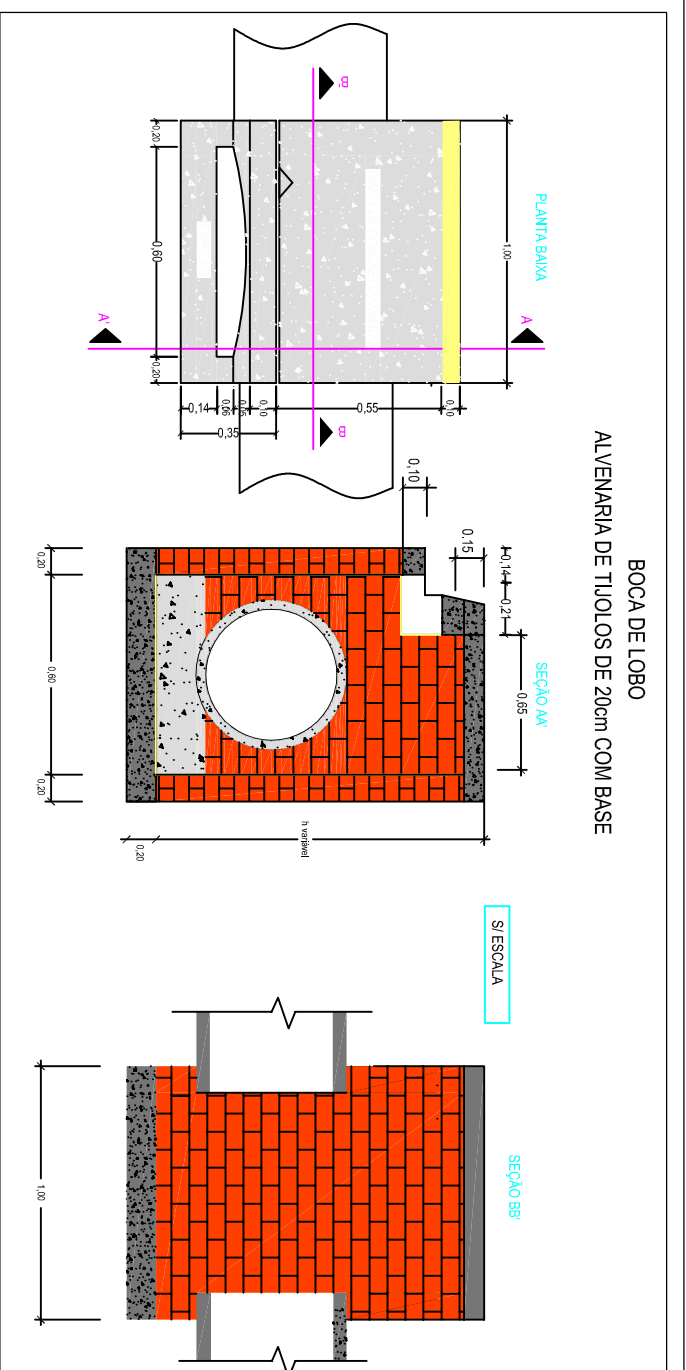

# PLANTA DRENAGEM

## ESCALA 1:650

**LEGENDA:**

- Coixa de Inspeção – Existente
- Boca de Lobo – Existente
- Boca de Lobo – Projetada
- ▨ Coixa de Inspeção – Projetada
- ▬ Tubo de Concreto Simples – PS1
- ▬ Tubo de Concreto Armado – PA1
- ▬ Meio Fio de Concreto
- ▬ Alça

<p>Av. Borges de Medeiros, 615 - Sala 104 Getúlio Vargas - RS - CEP 99900-000 Fone: 54-3341 3753 / 54-99950 5335</p>		<p>Resp. Técnico:</p>		<p>Cliente:</p>	
<p>Projeto : Lauson Serafini</p>		<p>Data : Novembro/2018</p>		<p>Resp. Técnico : Eng. Civil Lauson Serafini</p>	
<p>Desenho: Diego Kichel</p>		<p>Escala : Indicada</p>		<p>Cliente: Pref. Municipal de Tupanci do Sul</p>	
<p>Aprovação:</p>		<p>Revisão : 00</p>		<p>Local : Rua Gustavo Biazus</p>	
<p>-</p>		<p>Prancha : 08</p>		<p>Conteúdo: Planta de Drenagem Pluvial</p>	

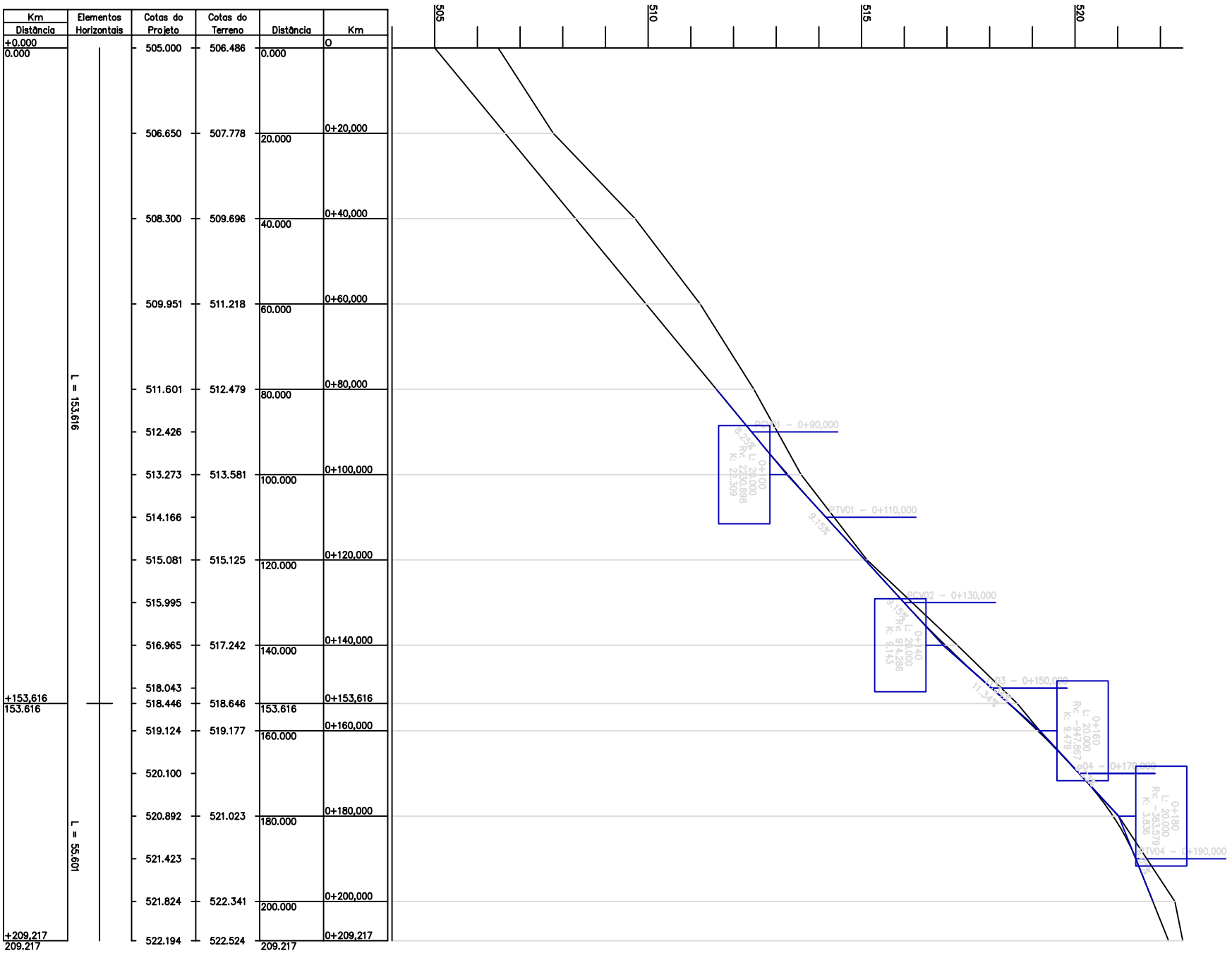

Perfil Longitudinal

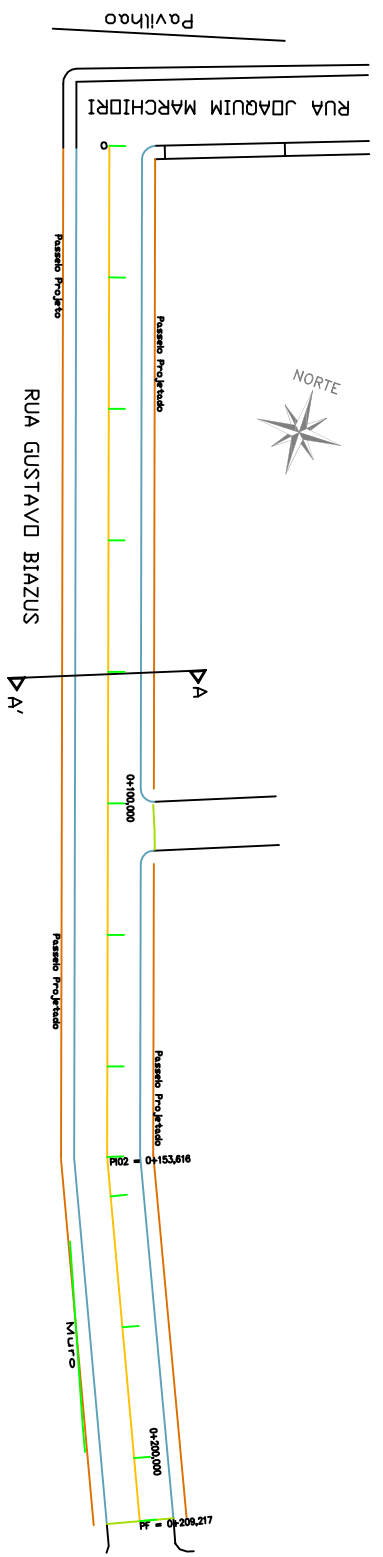

PLANTA GEOMÉTRICA  
ESCALA 1:750

Av. Borges de Medeiros, 615 - Sala 104 Getúlio Vargas - RS - CEP 99900-000 Fone: 54-3341 3753 / 54-99950 5335		Resp. Técnico:	Cliente:
Projeto: Lauson Serafini	Data: Novembro/2018	.....	
Desenho: Diego Kichel	Escala: Indicada	.....	
Aprovação:	Revisão: 00 Prancha: 09	Resp. Técnico: Eng. Civil Lauson Serafini CREA/RS 123168-D	Local: Rua Gustavo Biazus Conteúdo: Perfil Longitudinal
Cliente: Pref. Municipal de Tupanci do Sul CNPJ: 90.484.320/0001-57		Obra: Pavimentação Asfáltica	

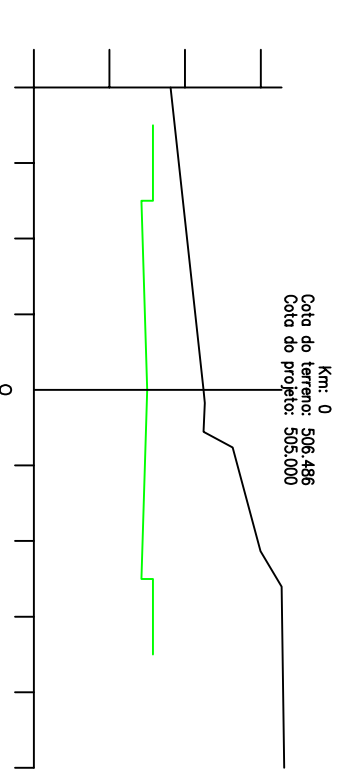
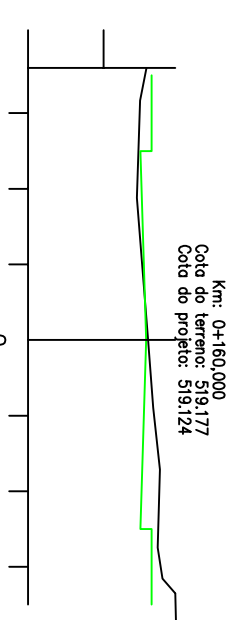
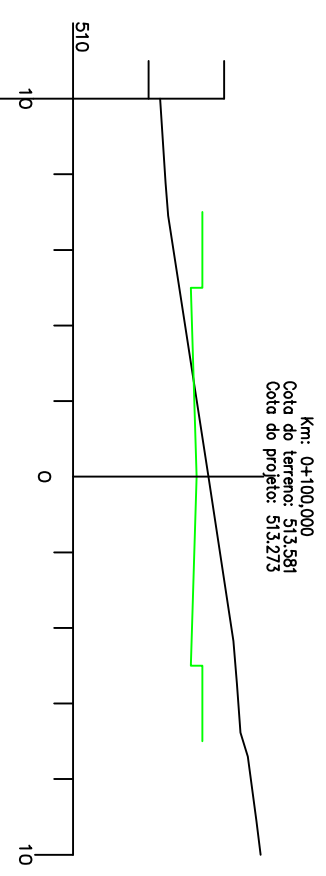
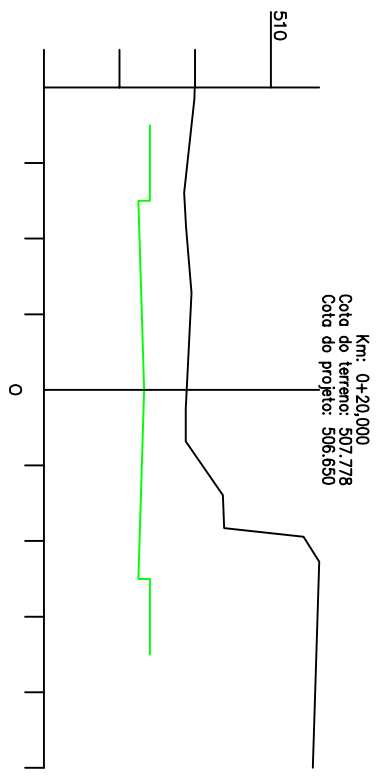
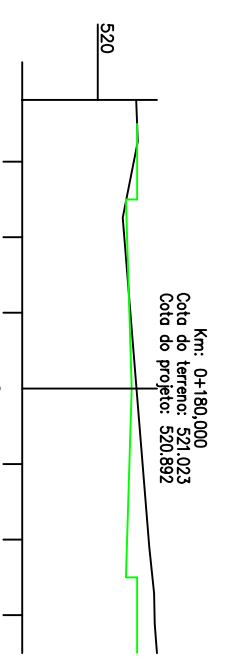
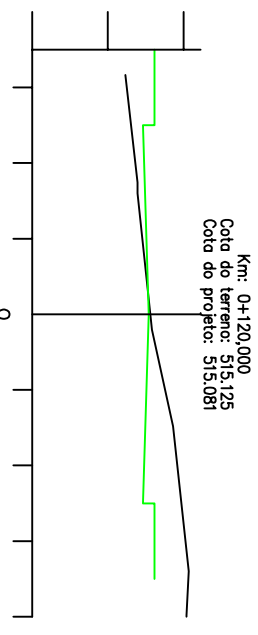
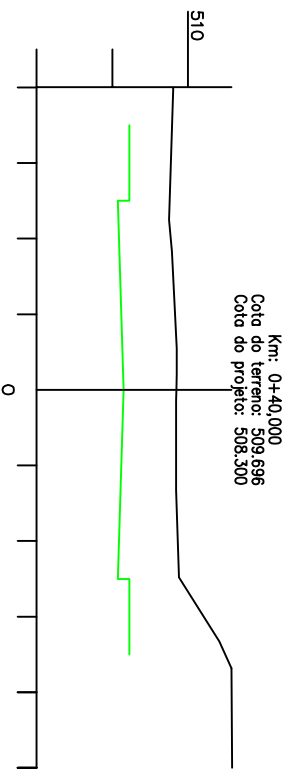
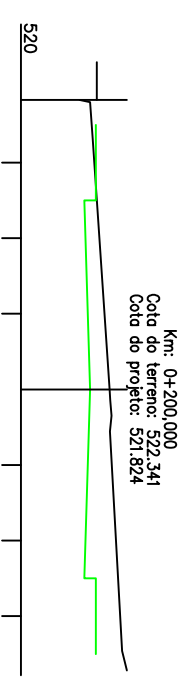
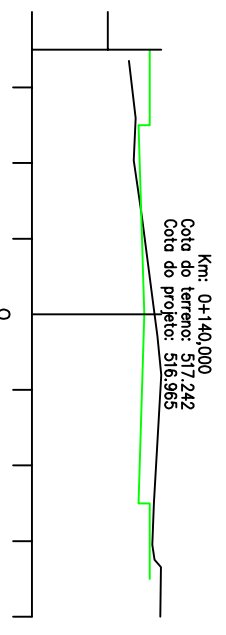
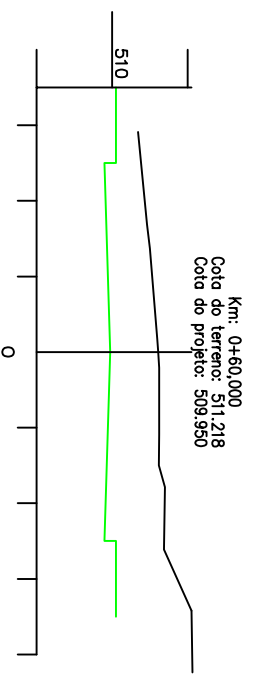
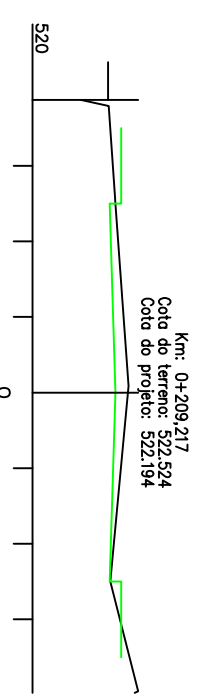
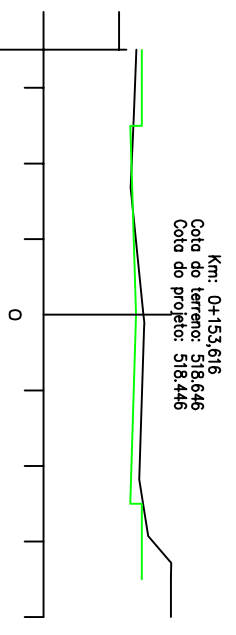
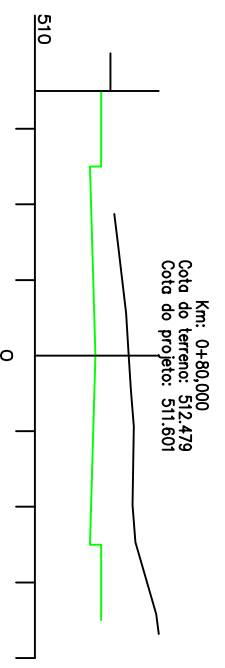



Av. Borges de Medeiros, 615 - Sala 104  
Getúlio Vargas - RS - CEP 99900-000  
Fone: 54-3341 3753 / 54-99950 5335

Resp. Técnico: .....

Cliente: .....

Projeto : <b>Lauson Serafini</b>	Data : <b>Novembro/2018</b>	Resp. Técnico : <b>Eng. Civil Lauson Serafini</b>	CREA/RS 123168-D
Desenho: <b>Diego Kichel</b>	Escala : <b>Indicada</b>	Cliente: <b>Pref. Municipal de Tupanci do Sul</b>	CNPJ: 90.484.320/0001-57
Aprovação: <b>-</b>	Revisão : <b>00</b>	Local : <b>Rua Gustavo Biazus</b>	
	Prancha : <b>10</b>	Conteúdo: <b>Seção Transversal</b>	



SINAL	CÓDIGO	NOME	QUANTIDADE
	R-1	Pare	02
	A32b	Passagem Sinalizada de Pedestres	04
	<b>PLACA DE NOME DE RUA - DUAS FACES</b> A = Rua Gustavo Biazus B = Rua Marcelino Marchiori C = Consular nome da rua junto à Prefeitura		02

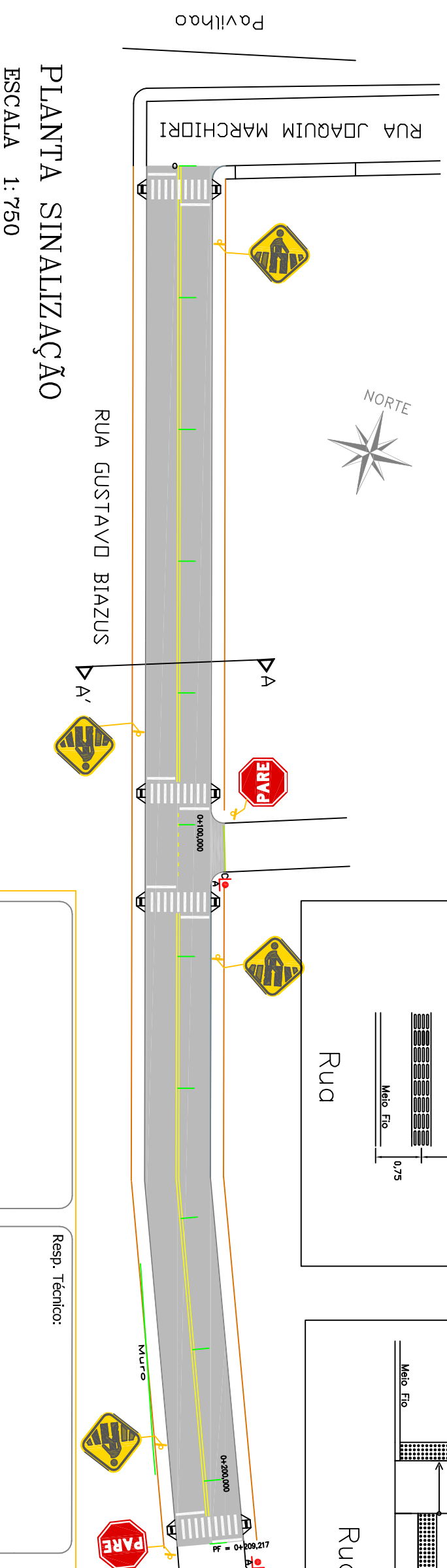
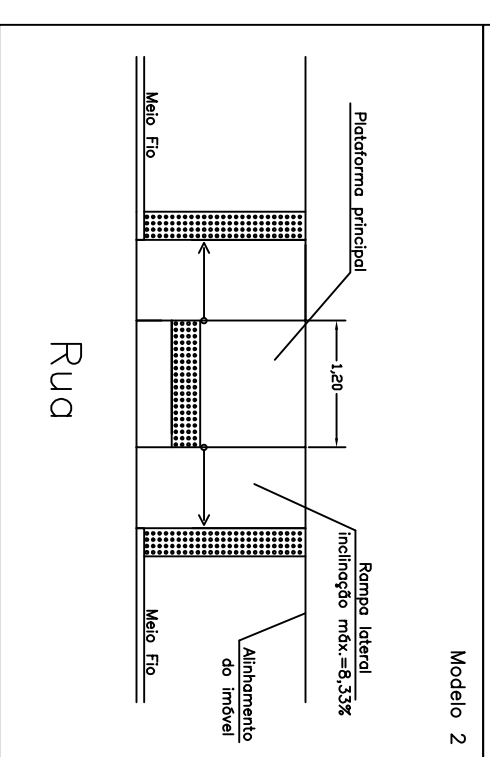
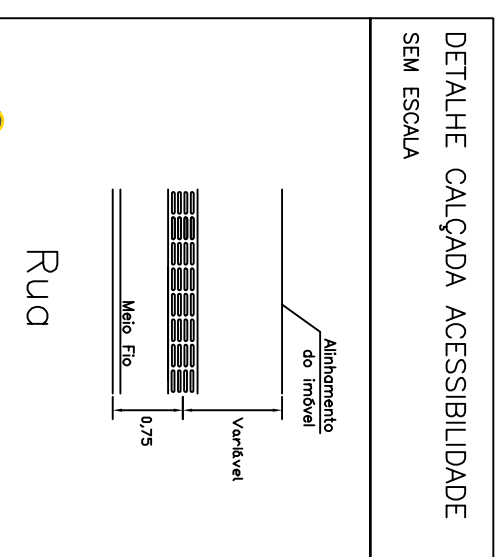
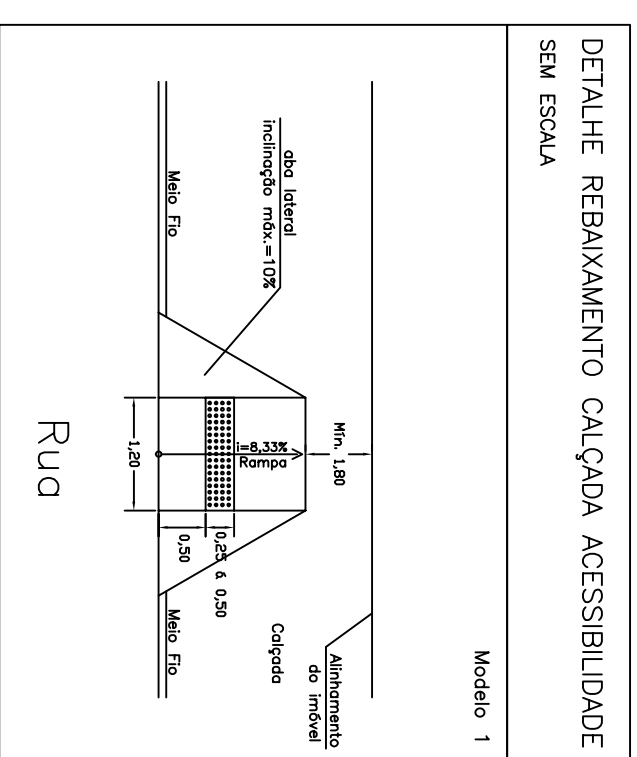
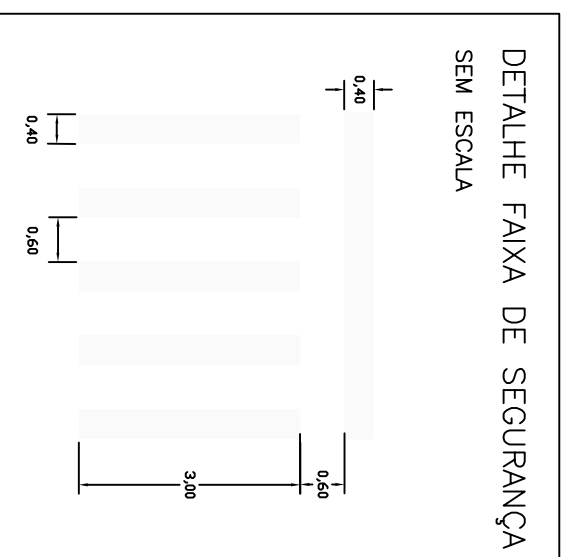

Projeto : <b>Lauson Serafini</b>		Data : <b>Novembro/2018</b>	
Desenho: <b>Diego Kichel</b>		Escala : <b>Indicada</b>	
Aprovação: -		Revisão : <b>00</b>	
Av. Borges de Medeiros, 615 - Sala 104 Getúlio Vargas - RS - CEP 99900-000 Fone: 54-3341 3753 / 54-99950 5335		Resp. Técnico: .....	
Cliente: <b>Pref. Municipal de Tupanci do Sul</b>		Resp. Técnico : <b>Eng. Civil Lauson Serafini</b>	
Obra: <b>Pavimentação Asfáltica</b>		CREA/RS 123168-D	
Local : <b>Rua Gustavo Biazus</b>		CNPJ: 90.484.320/0001-57	
Conteúdo: <b>Planta de Sinalização</b>		Cliente: .....	

**DETALHE DA IMPLANTAÇÃO REVESTIMENTO ASFÁLTICO**

	CBUQ	(e = 0,05 m)
	BGS	(e = 0,12 m)
	Macadame Seco	(e = 0,16 m)

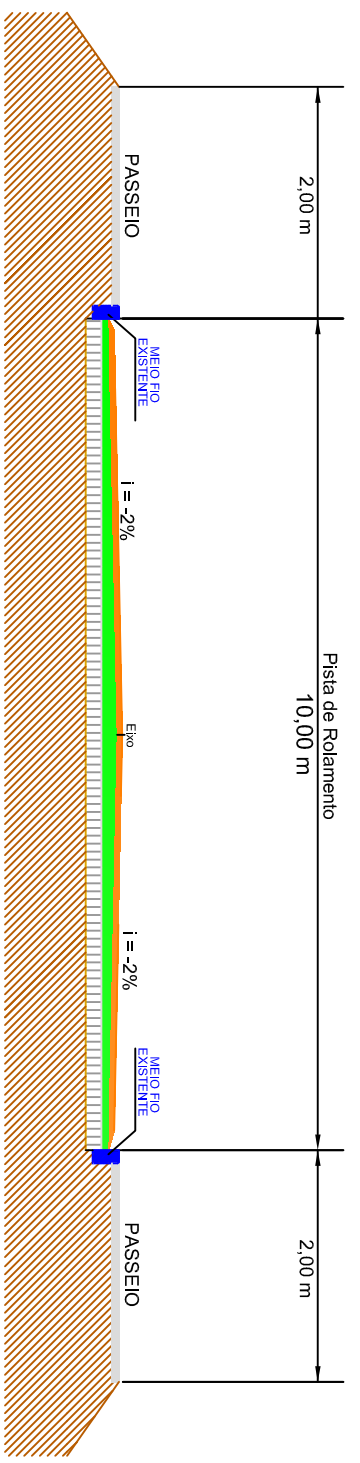

**CORTE A-A'**

Av. Luiz Panisson

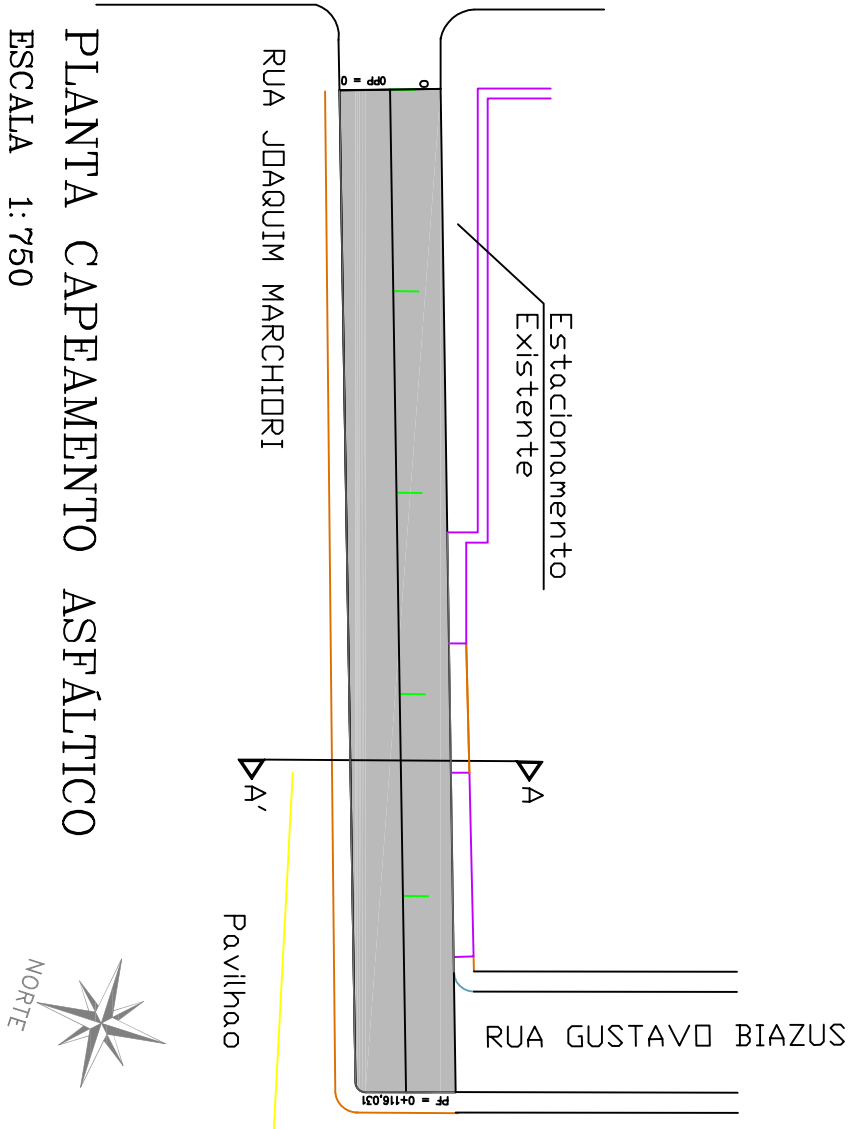

**PLANTA CAPEAMENTO ASFÁLTICO**  
ESCALA 1:750



Av. Borges de Medeiros, 615 - Sala 104 Getúlio Vargas - RS - CEP 99900-000 Fone: 54-3341 3753 / 54-99950 5335		Resp. Técnico: .....		Cliente: .....	
Projeto : Lauson Serafini	Data : Novembro/2018	Resp. Técnico : Eng. Civil Lauson Serafini	CREA/RS 123168-D		
Desenho: Diego Kichel	Escala : Indicada	Cliente: Pref. Municipal de Tupanci do Sul	CNPJ: 90.484.320/0001-57	Obra: Pavimentação Asfáltica	
Aprovação: -	Revisão : 00	Local : Rua Joaquim Marchiori		Conteúdo: Planta de Capçamento Asfáltico	
	Prancha : 01				

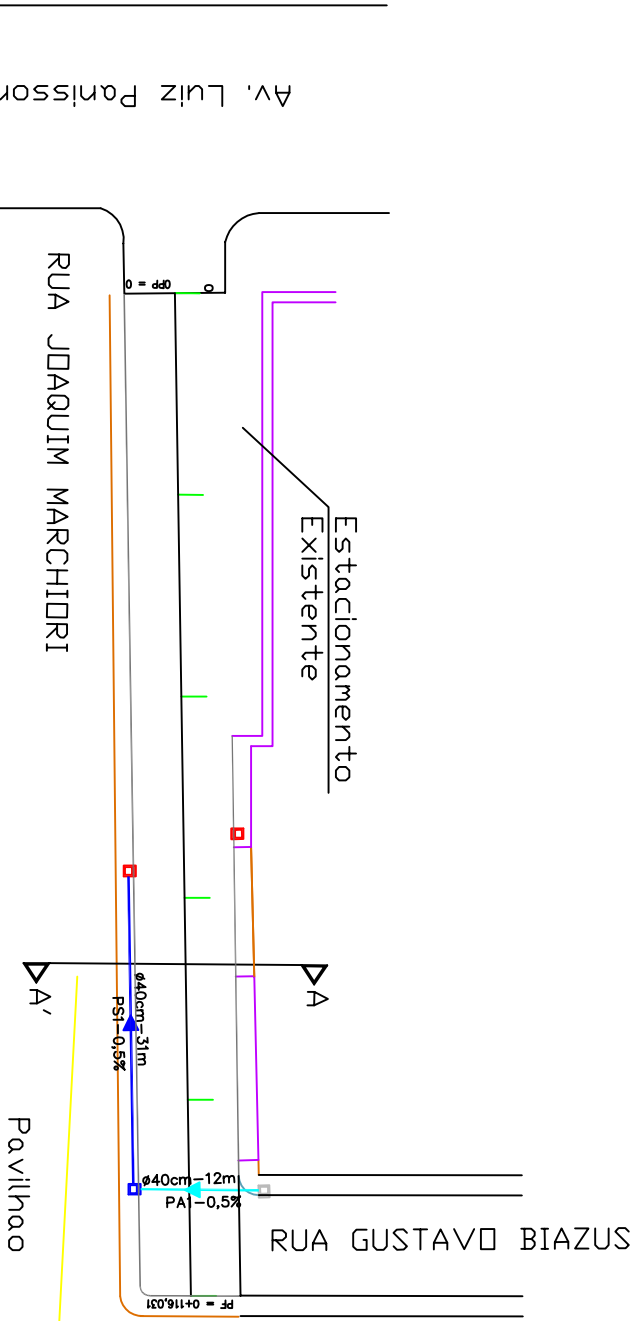
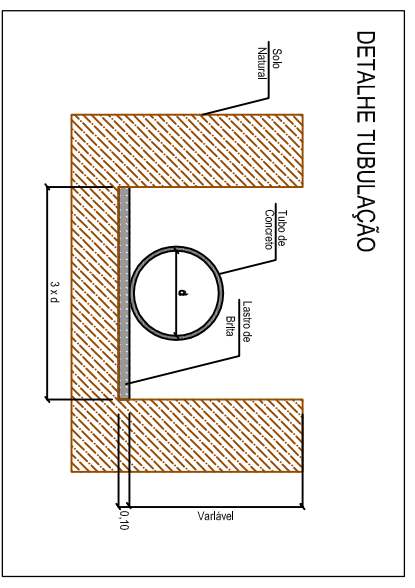
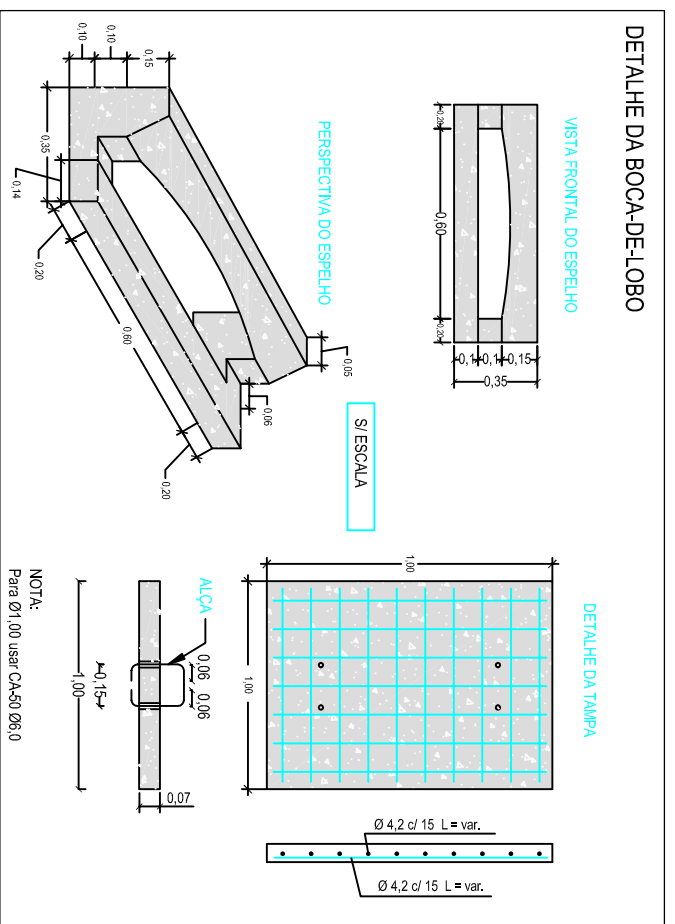
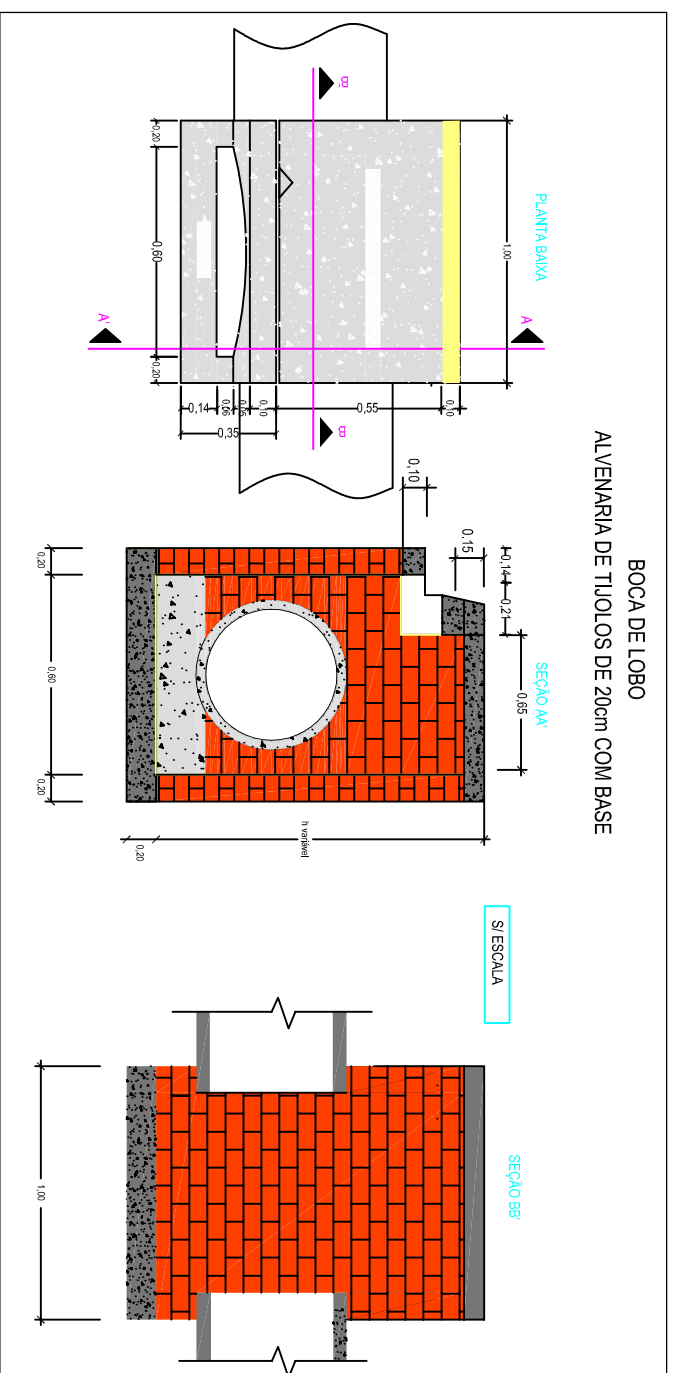

**LEGENDA:**

	Caixa de Inspeção – Existente
	Boca de Lobo – Existente
	Boca de Lobo – Projetada
	Caixa de Inspeção – Projetada
	Tubo de Concreto Simples – PS1
	Tubo de Concreto Armado – PA1
	Meio Fio de Concreto
	Ala

# PLANTA DRENAGEM

## ESCALA



<p>Projeto : Lauson Serafini</p> <p>Data : Novembro/2018</p> <p>Resp. Técnico:</p>		<p>Av. Borges de Medeiros, 615 - Sala 104 Getúlio Vargas - RS - CEP 99900-000 Fone: 54-3341 3753 / 54-99950 5335</p> <p>Resp. Técnico:</p>	
<p>Desenho: Diego Kichel</p> <p>Aprovação:</p>		<p>Resp. Técnico : Eng. Civil Lauson Serafini CREA/RS 123168-D</p> <p>Ciente: Pref. Municipal de Tupanci do Sul CNPJ: 90.484.320/0001-57</p>	
<p>Revisão : 00</p> <p>Prancha : 03</p>		<p>Obra: Pavimentação Asfáltica</p> <p>Local : Rua Joaquim Marchiori</p> <p>Conteúdo: Planta de Drenagem Pluvial</p>	

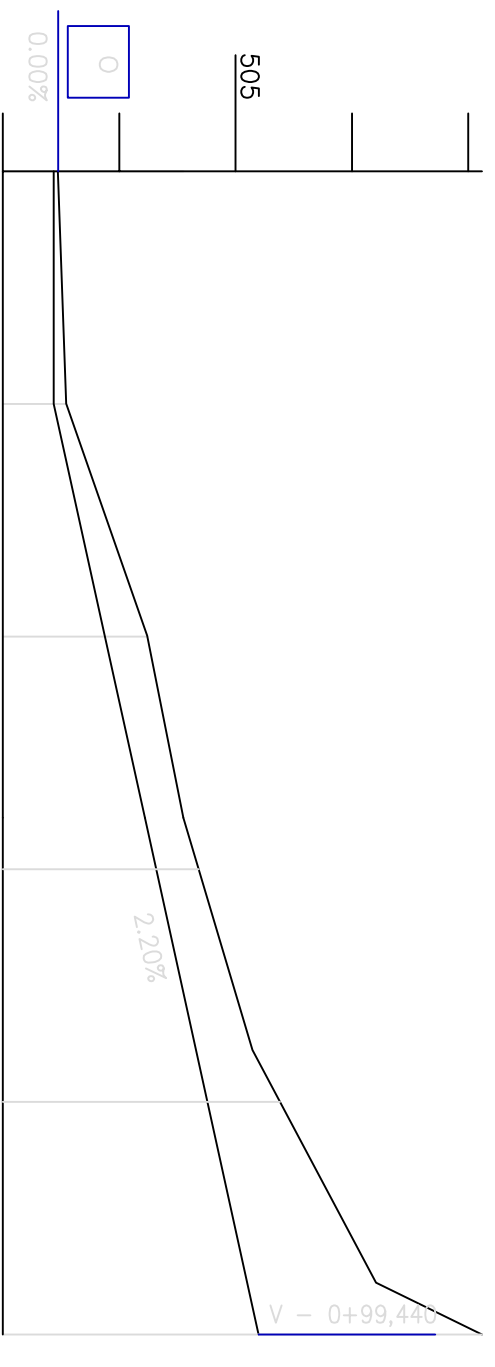

Km		Elementos Horizontais	Cotas do Projeto	Cotas do Terreno	Distância	Km
Distância						
+0.000	0.000	L = 99.449	503,340	503,412	0.000	0
			503,340	503,694	20.000	0+20,000
			503,780	504.176	40.000	0+40,000
			504.220	504.553	60.000	0+60,000
			504.660	505.146	80.000	0+80,000
+99,449	99.449		505.198	507.117	99.449	0+99,449

# PERFIL LONGITUDINAL

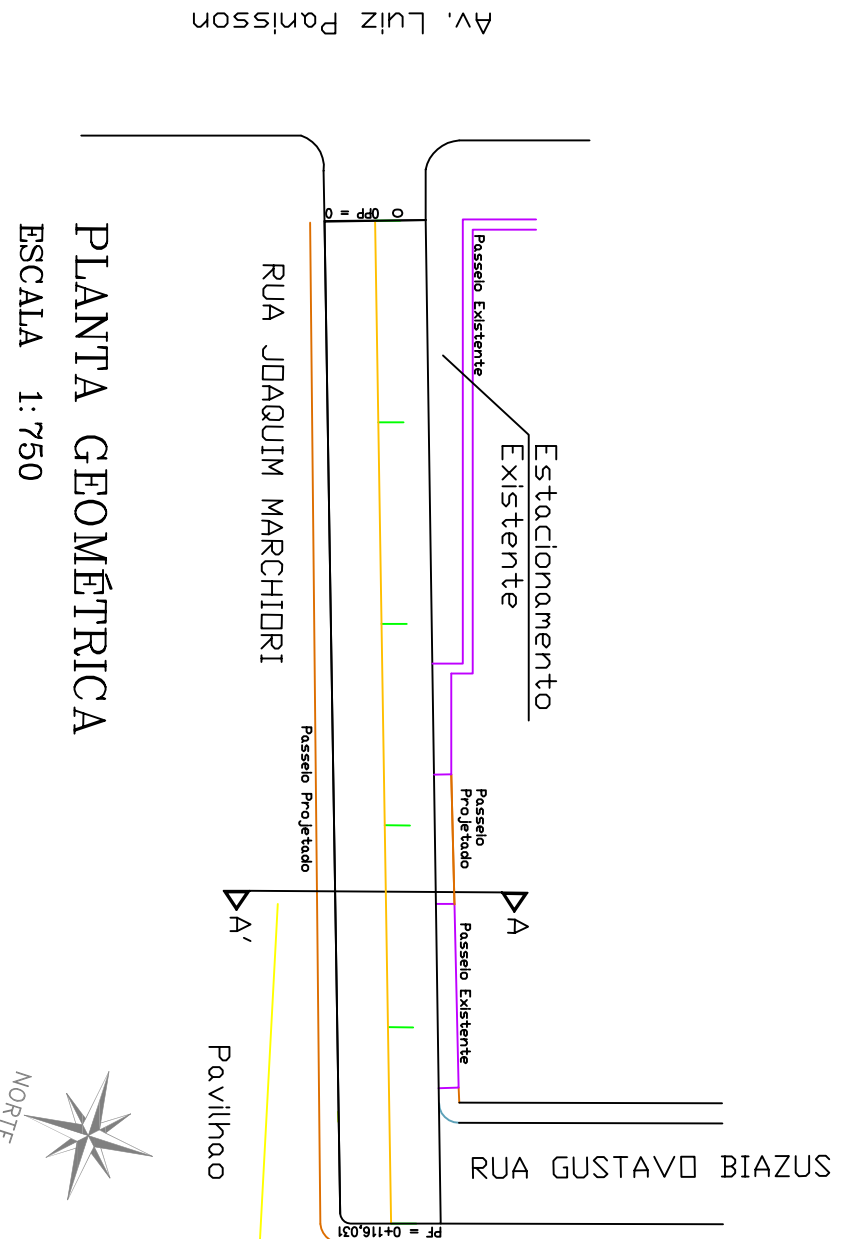

## PLANTA GEOMÉTRICA

ESCALA 1:750

Av. Borges de Medeiros, 615 - Sala 104 Getúlio Vargas - RS - CEP 99900-000 Fone: 54-3341 3753 / 54-99950 5335		Resp. Técnico: ..... Cliente: .....	
Projeto: Lauson Serafini Desenho: Diego Kichel Aprovação: -	Data: Novembro/2018 Escala: Indicada Revisão: 00 Prancha: 04	Resp. Técnico: Eng. Civil Lauson Serafini Cliente: Pref. Municipal de Tupanci do Sul CNPJ: 90.484.320/0001-57	CREA/RS 123168-D Obra: Pavimentação Asfáltica Local: Rua Joaquim Marchiori Conteúdo: Perfil Longitudinal

Km: 0+60,000  
 Cota do terreno: 504,553  
 Cota do projeto: 504,220

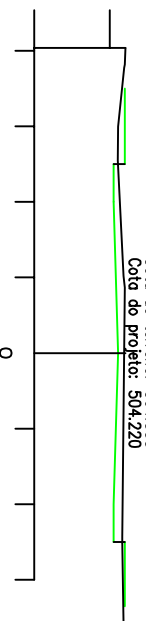

Km: 0+40,000  
 Cota do terreno: 504,780  
 Cota do projeto: 503,780

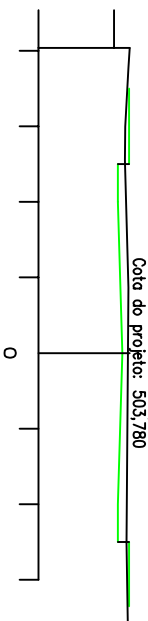

Km: 0+20,000  
 Cota do terreno: 503,694  
 Cota do projeto: 503,340

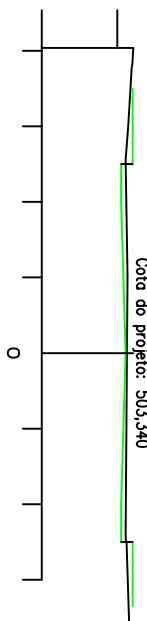

Km: 0  
 Cota do terreno: 503,412  
 Cota do projeto: 503,340



Km: 0+99,449  
 Cota do terreno: 506,207  
 Cota do projeto: 505,100

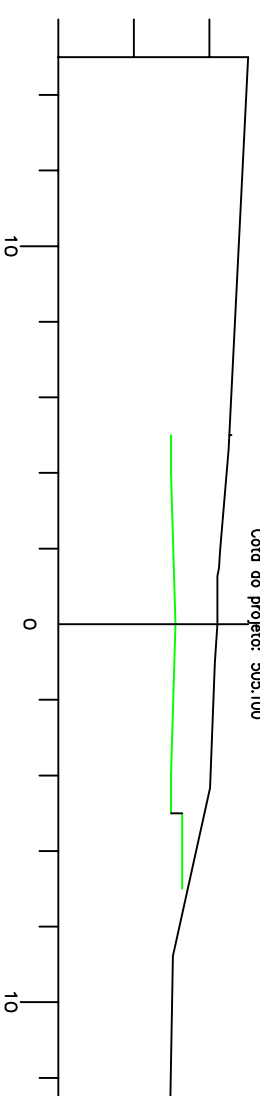

Km: 0+80,000  
 Cota do terreno: 505,146  
 Cota do projeto: 504,660

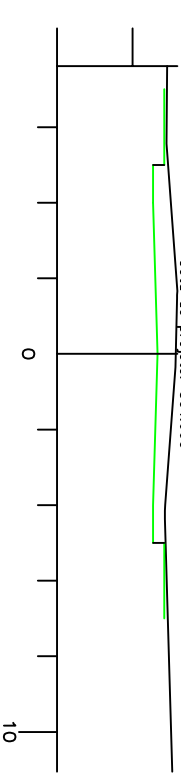

Av. Borges de Medeiros, 615 - Sala 104  
 Getúlio Vargas - RS - CEP 99900-000  
 Fone: 54-3341 3753 / 54-99950 5335

Resp. Técnico:  
 .....

Cliente:  
 .....

Projeto : Lauson Serafini	Data : Novembro/2018	Resp. Técnico : Eng. Civil Lauson Serafini	CREA/RS 123168-D
Desenho: Diego Kichel	Escala : Indicada	Cliente: Pref. Municipal de Tupanci do Sul	CNPJ: 90.484.320/0001-57
Aprovação: -	Revisão : 00	Local : Rua Joaquim Marchiori	
	Prancha : 05	Conteúdo: Seção Transversal	

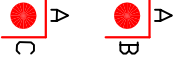
SINAL	CÓDIGO	NOME	QUANTIDADE
	A32b	Passagem Sinalizada de Pedestres	01
	PLACA DE NOME DE RUA - DUAS FACES		03
	A = Joaquim Marchiori B = Av. Luiz Panisson C = Rua Gustavo Biazus		

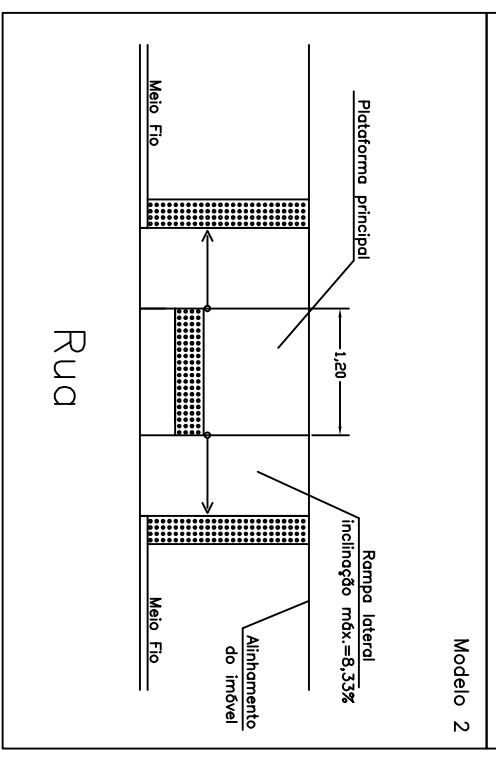
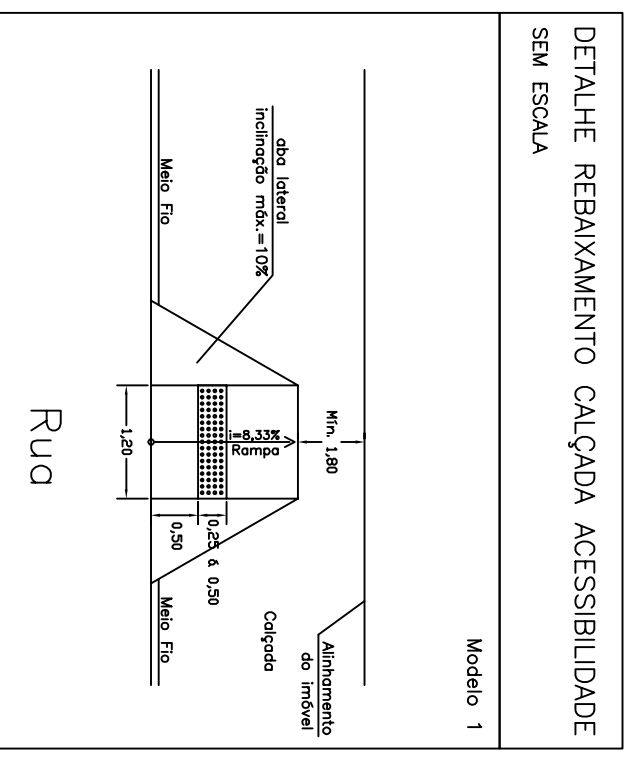
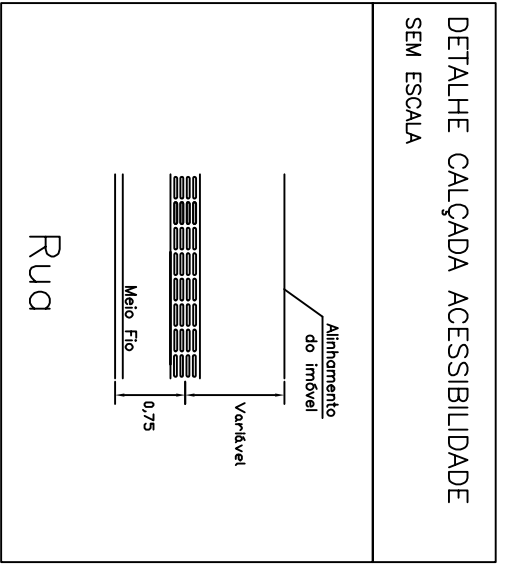
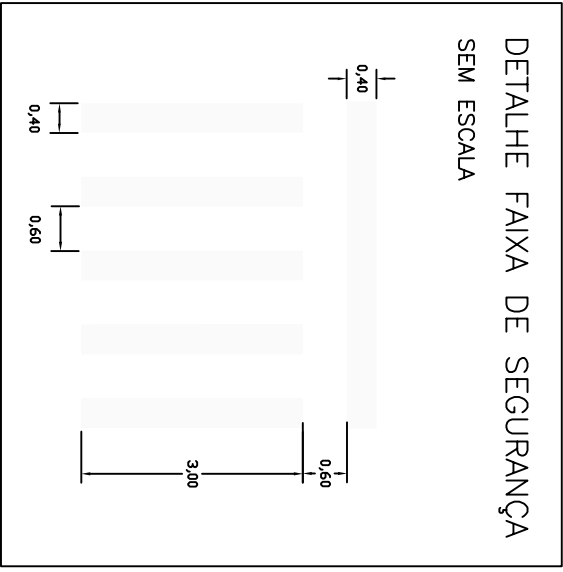
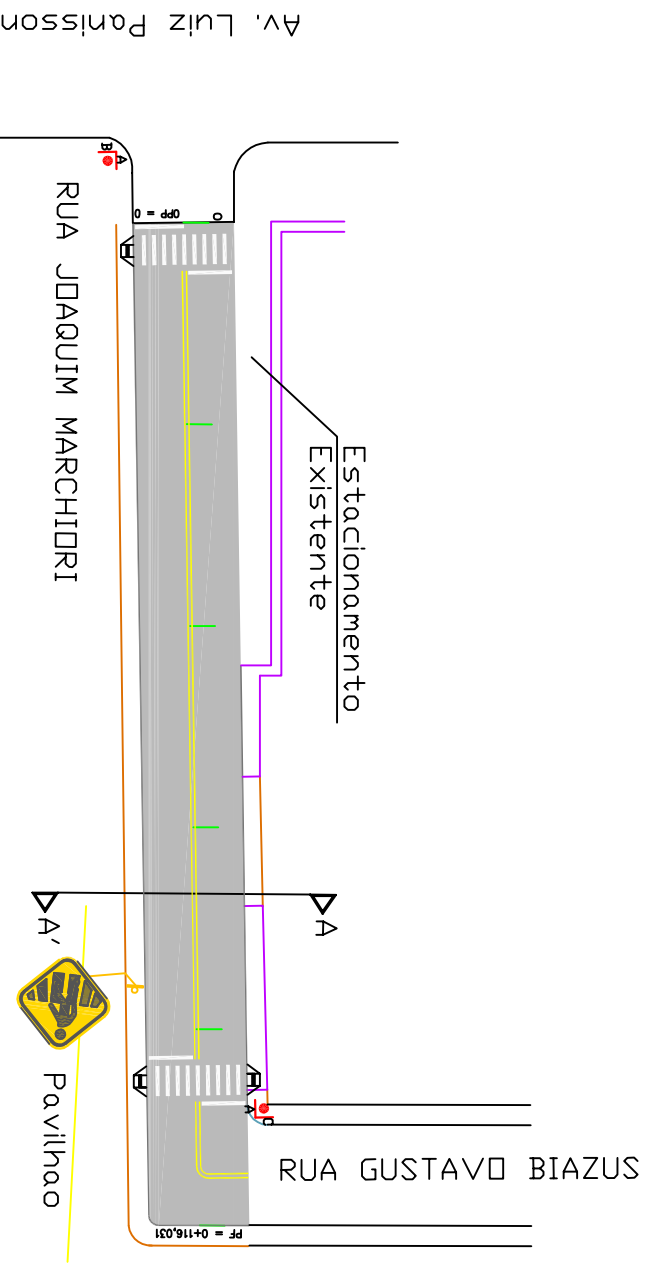

Av. Borges de Medeiros, 615 - Sala 104 Getúlio Vargas - RS - CEP 99900-000 Fone: 54-3341 3753 / 54-99950 5335		Resp. Técnico: .....	Cliente: .....
Projeto : Lauson Serafini	Data : Novembro/2018	Resp. Técnico : Eng. Civil Lauson Serafini	CREA/RS 123168-D
Desenho: Diego Kichel	Escala : Indicada	Cliente: Pref. Municipal de Tupanci do Sul	CNPJ: 90.484.320/0001-57
Aprovação: -	Revisão : 00	Obra: Pavimentação Asfáltica	Local : Rua Joaquim Marchiori
		Prancha : 02	Conteúdo: Planta de Sinalização